

TECOPPOINT®

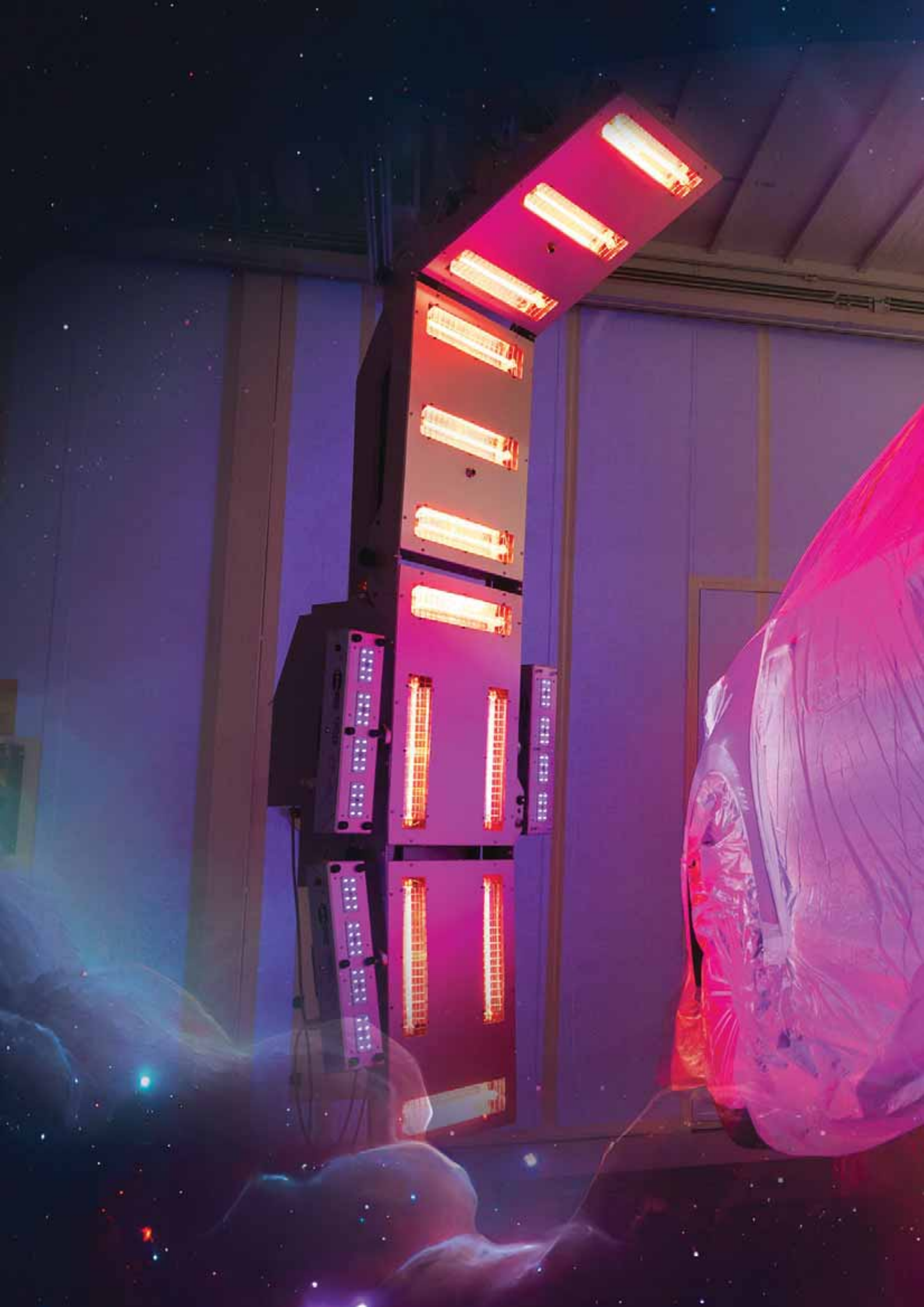

CATALOGO DIVISIONE
IR / UV 2024 





TETRA

SMART
INTEGRATION
IR - UV



ATTREZZATURE SPECIALI PER CARROZZERIE E OFFICINE





ASCO 3 è una delle più note aziende che operano nel campo della carrozzeria.

ASCO 3 fonda nel 2003 il marchio **TECOPOINT** con il quale progetta e produce **un' ampia gamma di macchinari** grazie ai notevoli investimenti in capitale e personale qualificato, portando avanti **un grande lavoro di ricerca e sviluppo.**

Per soddisfare le richieste di un mercato che chiede sempre maggiore velocità e professionalità, **ASCO 3 - TECOPOINT** propone la sua gamma di prodotti tramite le sue divisioni: **saldatura, aspirazione, infrarosso, UV-A e ZEUS Prep** un gestionale per zone di preparazione.







PAG. 7 • 11

-  **LEGENDA E DESCRIZIONE CENTRALINE DI CONTROLLO**
-  Infrared dryer Scheme - Control of drying times
-  Kodierung des Infrarot-Lacktrockners - Einstellen der Trocknungszeiten
-  Codification du sécheur à infrarouge - Gestion des temps de séchage
-  Codificación secador con infrarrojos - Gestión de los tiempos de secado

0 30 T





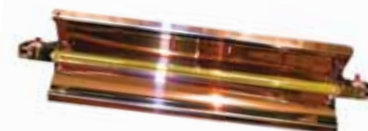

PAG. 12

-  **ACCESSORI / RICAMBI PER ESSICCATORI**
-  Spare parts for dryer
-  Zubehör für Lacktrockner
-  Accessoires pour sécheurs
-  Accesorios para secadores







PAG. 16 • 17

-  **ESSICCATORE CON CARRELLO TIPO 0**
-  Type 0 dryer with trolley
-  Lacktrockner mit Wagen Typ 0
-  Sécheur avec chariot type 0
-  Secador con carro tipo 0







PAG. 18

-  **ESSICCATORE CON CARRELLO TIPO 1**
-  Type 1 dryer with trolley
-  Lacktrockner mit Wagen Typ 1
-  Sécheur avec chariot type 1
-  Secador con carro tipo 1







PAG. 19 • 23

-  **ESSICCATORE CON CARRELLO TIPO 2**
-  Type 2 dryer with trolley
-  Lacktrockner mit Wagen Typ 2
-  Sécheur avec chariot type 2
-  Secador con carro tipo 2







PAG. 24 • 32

-  **ESSICCATORE TIPO 5 A SCORRIMENTO AEREO**
-  Type 5 dryer with overhead sliding system
-  Lacktrockner Typ 5 mit Überkopfverschiebung
-  Sécheur type 5 à glissement aérien
-  Secador tipo 5 con desplazamiento aéreo



PAG. 33 • 40

Lucciola UV-A LED

-  **LAMPADA PER ESSICCAZIONE AD ULTRAVIOLETTI UV-A**
-  UV-A curing
-  UV-A strahlungstrockner
-  Sécheurs radiants à spectre ultraviolet
-  Lámpara para secado con luz ultravioleta







PAG. 41

OPTIONAL



PAG. 42 • 46

LaBella Led

-  **LAMPADA PER ESSICCAZIONE AD ULTRAVIOLETTI E INFRAROSSI**
-  UV-IR curing
-  UV-IR strahlungstrockner
-  Sécheurs radiants à spectre ultraviolet et infrarouge
-  Lámpara para secado con luz ultravioleta e infrarrojos









LccL-8000-BAT





LAMPADA UV-A LED A BATTERIA
PER ESSICCAZIONE AD ULTRAVIOLETTI







 POTENZA
 Power
 Leistung
 Leistung
 Puissance









 CONTROLLO DIGITALE
 DIGITAL control
 DIGITAL Steuerung
 COMMANDE numérique
 CONTROL digital







 TENSIONE DI ALIMENTAZIONE
 Supply voltage
 Versorgungsspannung
 Versorgungsspannung
 Tension d'alimentation



 CONTROLLO TOUCH SCREEN
 TOUCH SCREEN control
 TOUCH-SCREEN Steuerung
 TOUCH-SCREEN Steuerung
 Contrôle écran tactile









 FUSIBILI RITARDATI
 Delayed fuses
 Sicherungen
 Sicherungen
 Fusibles à retardement







 MODELLO PLAFONIERA
 Cassette
 Lichtkastenmodell
 Lichtkastenmodell
 Modèle cassette



 SENSORE DI TEMPERATURA
 Temperature sensor
 Temperaturkontrolle
 Temperaturkontrolle
 Contrôle de temperature







 SUPERFICIE IRRADIATA
 Coverage area
 Bestrahlte Oberfläche
 Bestrahlte Oberfläche
 Surface chauffée









 SENSORE DISTANZA
 Distance control
 Distanzsensor
 Distanzsensor
 Capteur de distance







 DIMENSIONE LxPxH
 Size LxPxH
 Abmessungen LxPxH
 Abmessungen LxPxH
 Mésures LxPxH



 CONTROLLO A TIMER
 Timer control
 Steuerung mit zeitschaltuhr
 Steuerung mit zeitschaltuhr
 Contrôle avec minuteur



 PESO KG
 Weight Kg
 Gewicht Kg
 Gewicht Kg
 Poids Kg

ITALY **CONTROLLO "T" (TIMER)**

Il tempo di essiccazione, espresso in minuti, viene impostato manualmente mediante apposito timer meccanico.



"T" (TIMER) CONTROL

The drying period, expressed in minutes, is manually set up by a mechanical timer.



KONTROLLE "T" (TIMER)

Die Trocknungszeit, in Minuten ausgedrückt, wird manuell über die entsprechende mechanischen Zeitschaltuhr eingestellt.



CONTRÔLE "T" (MINUTEUR)

Le temps de séchage, exprimé en minutes, est paramétré manuellement au moyen du minuteur mécanique prévu à cet effet.



CONTROL "T" (TEMPORIZADOR)

El tiempo de secado, expresado en minutos, se configura manualmente mediante un temporizador mecánico adecuado.



ITALY **CONTROLLO "D" (DIGITALE)**

Il tempo di essiccazione viene gestito da una scheda elettronica con pannello di controllo digitale.

Vengono gestite la prima e la seconda fase dove:

- I° fase: è il tempo necessario per l'evaporazione del solvente (l'essiccatore funziona al 50% della potenza).
- II° fase: è il tempo di essiccazione del prodotto (l'essiccatore funziona al 100% della potenza).

Il controllo digitale consente di memorizzare i parametri di lavoro correnti (tempo prima fase e seconda fase), su quattro programmi. Per ciascuno di essi sono memorizzati il tempo I° fase ed il tempo II° fase.



"D" (DIGITAL) CONTROL

The drying time is automatically regulated by an electronic badge card, through a digital control panel. The control panel allows to operate with two phases:

- the first refers to the evaporation time of the solvent (the dryer works at 50% of its power);
- the second refers to the drying time of the product. In case of plastic or thermal-sensitive material, it is advisable to decrease the power.

The digital control allows to memorize the current working parameters (first and second phases time) on four program.



KONTROLLE "D" (DIGITAL)

Die Trocknungszeit wird über eine Leiterplatte mit einem Bedienfeld für die digitale Kontrolle eingestellt.

Es werden die erste und die zweite Phase eingestellt, wobei gilt:

I. Phase: ist die für die Verdunstung des Lösungsmittels notwendige Zeit (der Trockner arbeitet mit 50% der Leistung).

II. Phase: ist die Trocknungszeit des Produkts (der Trockner arbeitet mit 100% der Leistung).

Die Digitalkontrolle ermöglicht es, die aktuellen Arbeitsparameter (Zeiten der ersten und zweiten Phase)

auf vier Programmen zu speichern. Für jedes von diesen sind die Zeiten der I. und der II. Phase gespeichert.



CONTRÔLE "D" (NUMÉRIQUE)

Le temps de séchage est géré par une carte électronique avec panneau de contrôle numérique:

1ère phase : c'est le temps nécessaire à l'évaporation du solvant (le sécheur fonctionne à 50% de sa puissance).

2ème phase : c'est le temps de séchage du produit (le sécheur fonctionne à 100% de sa puissance).

Le contrôle numérique permet de mémoriser les paramètres de travail courants (temps première phase et deuxième phase), sur quatre programmes. Le temps de la 1ère phase et le temps de la 2ème phase sont mémorisés pour chacun de ces paramètres.



CONTROL "D" (DIGITAL)

El tiempo de secado es controlado por una tarjeta electrónica con panel de control digital.

Se controlan la primera y la segunda fase, donde:

- I° fase: es el tiempo necesario para la evaporación del disolvente (el secador funcional al 50% de su potencia).
- II° fase: es el tiempo de secado del producto (el secador funcional al 100% de su potencia).

El control digital permite memorizar los parámetros de trabajo actuales (tiempo de la primera fase y de la segunda), en cuatro programas.

Para cada uno de estos se memorizan el tiempo de la 1° y de la 2° fase.



CONTROLLO "DP" (DIGITALE CON PIROMETRO)

Il tempo di essiccazione viene gestito da una scheda elettronica con pannello di controllo digitale.

Un sensore pirometrico permette di mantenere costante la temperatura della superficie in corso di essiccazione.

- I° fase: è il tempo necessario per l'evaporazione del solvente (si consiglia di impostare una bassa temperatura pirometrica).

- II° fase: è il tempo di essiccazione del prodotto (si dovrà impostare la temperatura pirometrica massima a seconda del supporto verniciato).

Il controllo digitale consente di memorizzare i parametri di lavoro correnti (tempo e temperatura pirometrica di prima e seconda fase), su quattro programmi.

Grazie al sensore di temperatura pirometrica si può utilizzare l'essiccatore a potenza ridotta o controllata nel caso che i supporti verniciati siano materie plastiche o prodotti termo-sensibili.

“DP” (DIGITAL WITH PYROMETER) CONTROL

The drying time is automatically regulated by an electronic badge card, through a digital control panel. The drying surface temperature is kept constant thanks to a pyrometric sensor.

1st phase: consists in the time needed for the evaporation of the solvent (it is advisable the setting of a low pyrometric temperature)

2nd phase: consists in the drying time

(the pyrometric temperature will be set at the maximum level, according to the painted material).

The digital control permits the memorization of the current working parameters

(time and pyrometric temperature of 1st and 2nd phase), on four programs.

Possible use of the dryer at a reduced power when working with plastics or thermal-sensitive materials, thanks to the pyrometric sensor.

KONTROLLE "DP" (DIGITAL MIT PYROMETER)

Die Trocknungszeit wird über eine Leiterplatte mit einem Bedienfeld für die digitale Kontrolle eingestellt.

Ein pyrometrischer Sensor ermöglicht es, die Oberflächentemperatur während des Trocknens konstant zu halten.

I. Phase: ist die für die Verdunstung des Lösungsmittels notwendige Zeit (es wird empfohlen eine niedrige pyrometrische Temperatur einzustellen).

II. Phase: ist die Trocknungszeit des Produkts (es ist die je nach lackiertem Material maximale pyrometrische Temperatur einzustellen).

Die Digitalkontrolle ermöglicht es, die aktuellen Arbeitsparameter (Zeiten und pyrometrische Temperaturen der ersten und zweiten Phase) auf vier Programmen zu speichern.

Dank des Sensors für die pyrometrische Temperatur kann der Trockner für den Fall, dass die lackierten Materialien aus Plastik oder hitzeempfindliche Produkte sind, mit verminderter und kontrollierter Leistung verwendet werden.

CONTRÔLE "DP" (NUMÉRIQUE AVEC PYROMÈTRE)

Le temps de séchage est géré par une carte électronique avec panneau de contrôle numérique.

Un capteur pyrométrique permet de maintenir constante la température de la surface en cours de séchage.

1ère phase : c'est le temps nécessaire à l'évaporation du solvant (il est conseillé de configurer une température pyrométrique basse).

2ème phase : c'est le temps de séchage du produit (il faudra configurer la température pyrométrique maximale en fonction du support t peint).

Le contrôle numérique permet de mémoriser les paramètres de travail courants (temps et température pyrométrique de première et deuxième phase), sur quatre programmes.

CONTROL "DP" (DIGITAL CON PIROMETRO)

El tiempo de secado es controlado por una tarjeta electrónica con panel de control digital.

Un sensor pirométrico permite mantener constante la temperatura de la superficie que está secándose.

- I fase: es el tiempo necesario para la evaporación del disolvente (se aconseja configurar una temperatura pirométrica baja).

- II fase: es el tiempo de secado del producto (se deberá configurar la temperatura pirométrica máxima según el soporte barnizado).

El control digital permite memorizar los parámetros de trabajo actuales (tiempo y temperatura pirométrica de la primera fase y de la segunda), en cuatro programas.

Gracias a la temperatura pirométrica se puede utilizar el secador con potencia reducida o controlada en el caso de que los soportes barnizados sean materias plásticas o productos termosensibles.

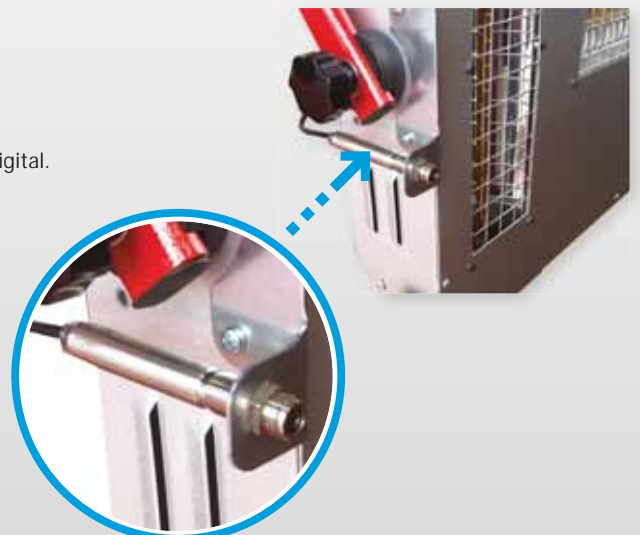

"ST" Control touch screen 

Steuerung Display 

Contrôle afficheur 





CONTROLLO "ST" (TOUCH SCREEN CON PIROMETRO E SENSORE DI DISTANZA)

Il tempo di essiccazione viene gestito da una scheda elettronica con pannello touch screen con sonda rilevamento temperatura, sonda rilevamento distanza e gestione digitale:

- NUOVO controllo TOUCH SCREEN con sensore di distanza.
- Il tempo di essiccazione viene gestito da una scheda elettronica con pannello di controllo digitale touch screen.
- Un sensore pirometrico abbinato a un sensore di distanza permette di mantenere costante la temperatura della superficie in corso di essiccazione.
- I° fase: è il tempo necessario per l'evaporazione del solvente (si consiglia di impostare una bassa temperatura pirometrica).
- II° fase: è il tempo di essiccazione del prodotto (si dovrà impostare la temperatura pirometrica massima a seconda del supporto verniciato).
- III fase: è il tempo di essiccazione del prodotto per eseguire un colpo finale di essiccazione, indispensabile per le nuove vernici ad acqua.
- Il controllo digitale consente di memorizzare i parametri di lavoro correnti (tempo e temperatura pirometrica di prima e seconda fase), su venti programmi alfanumerici.
- Grazie al sensore di temperatura pirometrica si può utilizzare l'essiccatore a potenza controllata nel caso che i supporti verniciati siano materie plastiche o prodotti termo-sensibili.
- Il sensore di distanza permette un controllo continuo e costante della distanza di lavorazione intervenendo con segnale acustico e sospendendo il lavoro al verificarsi del valore di distanza non adeguata.
- Funzione di preriscaldamento: importante funzione che permette di compensare il programma di lavoro con la temperatura ambiente esempio estate/inverno.

INDUSTRIA
4.0









-  Impostazione programmi con possibilità di memorizzare valori a piacere
-  Set of programmes-possibility of storing values
-  20 Möglichkeiten benutzerdefinierte Programme zu wählen
-  Possibilité de mémoriser des valeurs personnalisées
-  Configuración de programas con posibilidad de memorizar valores de la manera deseada







-  Report lavoro eseguito con visualizzazione consumo energetico
-  Report of work done with visual energy consumption
-  Bericht der ausgeführten Arbeit mit Anzeige des Energieverbrauchs
-  Rapport de travail avec consommation d'énergie visible sur l'écran
-  Informe de trabajo realizado con visualización de consumo energético





-  Controllo dati in esecuzione
-  Control data running
-  Datenkontrolle läuft
-  contrôle données en execution
-  Control datos en ejecución









-  Controllo distanza con segnalazione acustica per errori
-  Distance control with acoustic signal for error
-  Abstandkontrolle mit akustischer Fehlermeldung
-  Contrôle de distance avec signal acoustique
-  Control distancia con señalización acústica por errores



-  Controllo temperatura
-  Temperature control
-  Temperaturkontrolle
-  Contrôle température
-  Control temperatura



-  Inserimento testo per personalizzare i programmi
-  Text entering for programs customization
-  Texteingfügung für Programmanpassung
-  Insertion de texte pour personnaliser les programmes
-  Introducción de texto para personalizar los programas

 "ST" CONTROL (TOUCH SCREEN + PYROMETER + DISTANCE SENSOR)

The drying time is regulated by an electronic badge card, through a touch screen panel with temperature and distance sensors:

New touch screen control panel with distance sensor

two sensors – pyrometric and distance allow to keep the temperature of the drying surface at a constant level.

- 1st phase: consists in the time needed for the evaporation of the solvent (it is advisable the setting of a low pyrometric temperature).
- 2nd phase: consists in the drying time (the pyrometric temperature will be set at the maximum level, according to the painted material)
- 3rd phase: it is necessary to complete the work with the new water paints.

The digital control allows the memorization of the current working parameters (time and pyrometric temperature of 1st and 2nd phase) on 20 programmes. Possible use of the dryer at a reduced power when working with plastics or thermal-sensitive materials, thanks to the pyrometer. The distance sensor allows a constant control of the working distance interrupting the process thanks to an acoustic signal in case of incorrect distance

pre-heating function: allows to compensate the working program with the room temperature.

 KONTROLLE "ST" (TOUCH SCREEN MIT PYROMETER UND DISTANZSENSOR)

Die Trocknungszeit wird über eine Leiterplatte mit einem Touch-Screen-Bedienfeld mit einer Sonde zur Temperaturmessung, einer Sonde zur Distanzmessung und einer Digitalsteuerung eingestellt.: NEUE Kontrolle TOUCH SCREEN mit Distanzsensor.

Die Trocknungszeit wird über Leiterplatte mit einem Touch-Screen-Bedienfeld eingestellt.

Ein pyrometrischer Sensor ermöglicht es in Kombination mit einem Distanzsensor, die Oberflächentemperatur während des Trocknens konstant zu halten.

- I. Phase: ist die für die Verdunstung des Lösungsmittels notwendige Zeit (es wird empfohlen eine niedrige pyrometrische Temperatur einzustellen).
- II. Phase: ist die Trocknungszeit des Produkts (es ist die je nach lackiertem Material maximale pyrometrische Temperatur einzustellen).
- III. Phase: ist die Trocknungszeit des Produkts, um die

Abschluss-trocknung durchzuführen, die für die neuen Lacke auf Wasserbasis unverzichtbar sind.

Die Digitalkontrolle ermöglicht es, die aktuellen Arbeitsparameter (Zeiten und pyrometrische Temperaturen der ersten und zweiten Phase) auf zwanzig alphanumerischen Programmen zu speichern.

Dank des Sensors für die pyrometrische Temperatur kann der Trockner für den Fall, dass die lackierten Materialien aus Plastik oder **hitzeempfindliche Produkte sind, mit verminderter und kontrollierter Leistung verwendet werden.**

Der Distanzsensor ermöglicht eine kontinuierliche und konstante Kontrolle der Bearbeitungsdistanz und gibt beim Vorkommen eines nicht geeigneten Distanzwerts ein akustisches Signal ab und unterbricht den

Arbeitsvorgang. Vorerhitzungsfunktion: eine wichtig Funktion, die es ermöglicht, das Arbeitsprogramm zu kompensieren.

 CONTRÔLE "ST" (TOUCH SCREEN AVEC PYROMÈTRE ET CAPTEUR DE DISTANCE)

Le temps de séchage est géré par une carte de électronique avec un panneau tactile, une sonde de relevé de la température, une sonde de relevé de la distance et une gestion numérique :

NOUVEAU contrôle TOUCH SCREEN avec capteur de distance

Le temps de séchage est géré par une carte électronique avec panneau de contrôle numérique tactile

Un capteur pyrométrique associé à un capteur de distance permet de maintenir constante la température de la surface en cours de séchage.

- 1ère phase : c'est le temps nécessaire à l'évaporation du solvant (il est conseillé de configurer une température pyrométrique basse).
- 2ème phase : c'est le temps de séchage du produit (il faudra configurer la température maximale en fonction du support peint).
- 3ème phase : c'est le temps de séchage du produit pour effectuer l'étape finale de séchage, indispensable pour les nouvelles peintures à l'eau.

Le contrôle numérique permet de mémoriser les paramètres de travail courants (temps et température pyrométrique de première et de deuxième phase), sur vingt programmes alphanumériques.

Grâce au capteur de température pyrométrique, on peut utiliser le sécheur à puissance contrôlée selon que les supports peints sont en matières plastiques ou des produits thermosensibles. Le capteur de distance permet un contrôle continu et constant de la distance de travail en intervenant avec un signal acoustique et en suspendant le travail si la distance n'est pas appropriée.

Fonction de préchauffage : fonction importante qui permet de compenser le programme de travail.

 CONTROL "ST" (PANTALLA TÁCTIL CON PIRÓMETRO Y SENSOR DE DISTANCIA)

El tiempo de secado es controlado por una tarjeta electrónica con panel con pantalla táctil con sonda de detección de temperatura, sonda de detección de distancia y control digital.

Control NUEVO con PANTALLA TÁCTIL con sensor de distancia

El tiempo de secado es controlado por una tarjeta electrónica con panel de control digital con pantalla táctil.

Un sensor pirométrico unido a un sensor de distancia permite mantener constante la temperatura de la superficie que está secándose.

- Iª fase: es el tiempo necesario para la evaporación del disolvente (se aconseja configurar una temperatura pirométrica baja).
- IIª fase: es el tiempo de secado del producto (se deberá configurar la temperatura pirométrica máxima según el soporte barnizado).
- IIIª fase: es el tiempo de secado del producto para realizar un golpe de secado final, indispensable para los nuevos barnices con agua.





El control digital permite memorizar los parámetros de trabajo actuales (tiempo y temperatura pirométrica de la primera fase y de la segunda), en veinte programas alfanuméricos.

Gracias al sensor de temperatura pirométrica se puede utilizar el secador con potencia controlada en el caso de que los soportes barnizados sean materias plásticas o productos termosensibles.

El sensor de distancia permite un control continuo y constante de la distancia de elaboración interviniendo con señal acústica y suspendiendo el trabajo al comprobarse un valor de distancia no adecuado.

Función de precalentamiento: función importante que permite compensar el programa de trabajo con la temperatura ambiente, por ejemplo, verano/invierno.

Art. 13051450

-  **Copertura protezione plafoniera**
-  Cover protection for cassette
-  Schutzabdeckung Lichtkasten
-  Couverture protection cassette
-  Tapa protección tapón







Art. 13051490

-  **Puntatore laser**
-  Laser pointer
-  Laserpointer
-  Pointeur laser
-  Puntero láser







Art. 70260550

-  **Corpo Radiante Emettitore 1000W L=300 mm**
-  Radiant Emitter 1000W L=300 mm
-  Strahlungsemitter 1000W L=300 mm
-  Corps Rayonnant Émetteur 1000W L=300 mm
-  Cuerpo Radiante Emisor 1000W L=300 mm



Art. 70260555

-  **Corpo Radiante Emettitore 1000W L=300 mm con cavo**
-  Radiant Emitter 1000W L=300 mm
-  Strahlungsemitter 1000W L=300 mm
-  Corps Rayonnant Émetteur 1000W L=300 mm
-  Cuerpo Radiante Emisor 1000W L=300 mm con cable



Art. 70260560

-  **Corpo Radiante Emettitore 1500W L=300 mm con cavo**
-  Radiant Emitter 1500W L=300 mm
-  Strahlungsemitter 1500W L=300 mm
-  Corps Rayonnant Émetteur 1500W L=300 mm
-  Cuerpo Radiante Emisor 1500W L=300 mm



Art. 70260562

-  **Corpo Radiante Emettitore 2000W L=300 mm con cavo**
-  Radiant Emitter 2000W L=300 mm
-  Strahlungsemitter 2000W L=300 mm
-  Corps Rayonnant Émetteur 2000W L=300 mm
-  Cuerpo Radiante Emisor 2000W Con Cable L=300 mm







Art. 70260565

-  **Corpo Radiante Emettitore 2000W L=490 mm con cavo**
-  Radiant Emitter 2000W L=490 mm
-  Strahlungsemitter 2000W L=490 mm
-  Corps Rayonnant Émetteur 2000W L=490 mm
-  Cuerpo Radiante Emisor 2000W con cable L=490 mm







Art. 13094500

-  **Occhiale Lente Gialla Per Uv**
-  Yellow Lenses Glasses For Uv
-  Gelbe Linsenbrille Für Uv
-  Verres Jaunes Pour Uv
-  Lentes De Lentes Amarillas Para



-  **Lampada alogena a raggi infrarossi usata come sorgente di calore ad alta efficienza e potenza per impianti di verniciatura e altre applicazioni industriali, che prevedono l'impiego di un rivestimento speciale utile a ridurre il bagliore emesso.**
-  Tubular infrared halogen lamp used as high-power and high efficiency heat source for painting areas various industrial application with a specific coating reducing glare emission.
-  Halogenlampe mit Infrarotstrahlen als hocheffiziente und leistungsstarke Wärmequelle für Lackieranlagen und andere industrielle Anwendungen verwendet, die den Einsatz einer Spezialbeschichtung vorsehen, die dazu dient, das abgegebene blendende Licht zu verringern.
-  Lampe halogène à rayons infrarouges utilisée comme source de chaleur de haute efficacité et de grande puissance pour des équipements de peinture et d'autres applications industrielles, qui prévoient l'utilisation d'un revêtement spécial utile pour réduire la lueur émise.
-  Lámpara halógena con rayos infrarrojos usada como fuente de calor con eficiencia alta y potencia para equipos de barnizado y otras aplicaciones industriales que prevean el uso de un revestimiento especial útil para reducir el resplandor emitido.

-  **Bagliore meno visibile rispetto alle lampade chiare o di colore rubino grazie al rivestimento unico nel suo genere. Più del 95% dell'energia in input è emessa sotto forma di radiazione termica infrarossa**
-  Lower visible glare compared to clear or ruby lamps
-  Dank der für ihren Sektor einzigartigen Beschichtung ist blendendes Licht weniger sichtbar als im Vergleich zu transparenten Lampen oder Lampen in rubinroter Farbe.
-  Lueur moins visible par rapport aux lampes claires ou de couleur rubis grâce au revêtement unique en son genre
-  Resplandor menos visible con respecto a las lámparas claras o de color rubí gracias al revestimiento único en su género. Más del 95% de la energía que entre es emitida en forma de radiación térmica infrarroja.

- **Alta potenza ed efficienza**
- **Essiccatore di infrarosso ad altissimo rendimento**
- **Specifica per essiccazione vernici**
- **High power and high efficiency**
- **Very high performance infrared generator**
- **Specific for paint drying**
- **Hohe Leistung und Effizienz**
- **Hochleistungsfähiger Infrarot-Lacktrockner**
- **Speziell für Lacktrocknung**
- **Puissance et efficacité élevées**
- **Sécheur à infrarouge à très haut rendement**
- **Spécifique pour le séchage des peintures**
- **Potencia y eficiencia altas**
- **Secado de infrarrojos con un rendimiento muy alto**
- **Especificación para secado barnices**



STR

SISTEMA ROBOTIZZATO
PER ESSICCAZIONE VERNICI

FORNETTO PER CERCHIONI

TecoPoint rim oven

Art. 13051350



Il fornetto per cerchioni TecoPoint permette di essiccare rapidamente i vostri cerchioni.

Sfrutta tutta la potenza delle lampade ad Infrarosso TecoPoint già famose per la loro altissima resa e qualità.

Il controllo DP ha a disposizione 4 programmi personalizzabili.

Il sensore di temperatura, pirometro, permette di regolare al meglio la potenza irradiata e garantisce il massimo risparmio energetico dando una mano anche all'ambiente



The TecoPoint rim dryer allows you to quickly dry your rims.

It exploits all the power of TecoPoint infrared lamps already famous for their very high yield and quality.

The DP control has 4 customizable programs available.

The temperature sensor, pyrometer, allows you to best regulate the radiated power and guarantees maximum energy savings while also helping the environment.



BASE FORNETTO PER PROVINI



Fornetto con essiccatore ad infrarosso portatile TecoPoint.

Il fornello con essiccatore ad infrarosso portatile TecoPoint permette di sfruttare tutta la potenza della radiazione Infrarossa per essiccare rapidamente i vostri provini. E' compatibile con gli essiccatori TecoPoint serie 010 e 010 TR. Quest'ultimo è particolarmente adatto perché provvisto di regolatore di potenza.



TecoPoint oven with infrared portable dryer.

The TecoPoint oven with portable infrared dryer allows you to exploit all the power of infrared radiation to quickly dry your specimens. It is compatible with TecoPoint 010 and 010 TR series dryers. The latter is particularly suitable because it is equipped with a power regulator.

Art. 13051520

BASE FORNETTO PER 010TR

Misure interne

49 x 32 x 32 H cm

Misure esterne

(senza maniglie)

50 x 35 x 40 H cm



OPTIONAL

Art. 13051510

- Piedistallo piantana
- Stand
- Säule
- Pilier
- Pedestal poste



Art. 13051560

010TR ESSICCATORE AD INFRAROSSO A ONDE CORTE

Portatile con timer e regolazione della potenza 230v. 1000w



Regolazione della potenza
Power regulation



PORTABLE DRYER WITH TIMER



TRAGBARE INFRAROT-TROCKNER MIT TIMER



SÈCHEUR À INFRAROUGE AVEC MINUTEUR



SECADOR CON INFRARROJO PORTÁTIL CON TEMPORIZADOR



010 T

- Onde corte
- Short waves
- Kurzwellen
- Ondes courtes
- Ondas Cortas



PIEDISTALLO

OPTIONAL
Art. 13051510

- Piedistallo piantana
- Stand
- Säule
- Pilier
- Pedestal poste



Essiccatore ad infrarosso a ONDE CORTE ad alto rendimento

- Riscaldamento istantaneo, piena potenza entro un secondo dall'accensione
- Energia pulita: nessun problema di inquinamento causato dall'emissione di raggi infrarossi
- Controllo a timer
- Grande manovrabilità della plafoniera



Very high performance infrared generator

- Instant heat, full power with in one second at switching on
- Clean energy: no pollution emitted by infrared lamps
- Timer control
- Wide manoeuvrability of the cassette



KURZWELLEN-Infrarotstrahler mit hoher Leistung

- Sofortige Aufwärmung, volle Leistung innerhalb einer Sekunde
- Saubere Energie: durch die Strahlung entstehen keine Umweltverschmutzungen
- Steuerung mit Zeitschaltuhr
- Große Manövrierfähigkeit des Kassettes



Sécheur à infrarouge à ONDES COURTES haute efficacité

- Chaleur instantanée, pleine puissance en 1 seconde
- Energie propre: aucune pollution environnementale due au rayonnement infrarouge
- Contrôle avec minuteur
- Grande manoeuvrabilité de la cassette



Secador con infrarrojo con ONDAS CORTAS con alto rendimiento

- Calentamiento instantáneo, potencia plena pasado un segundo del encendido
- Energía limpia: ningún problema de contaminación causado por la emisión de rayos infrarrojos
- Control con temporizador
- Gran maniobrabilidad del plafón

020 B T

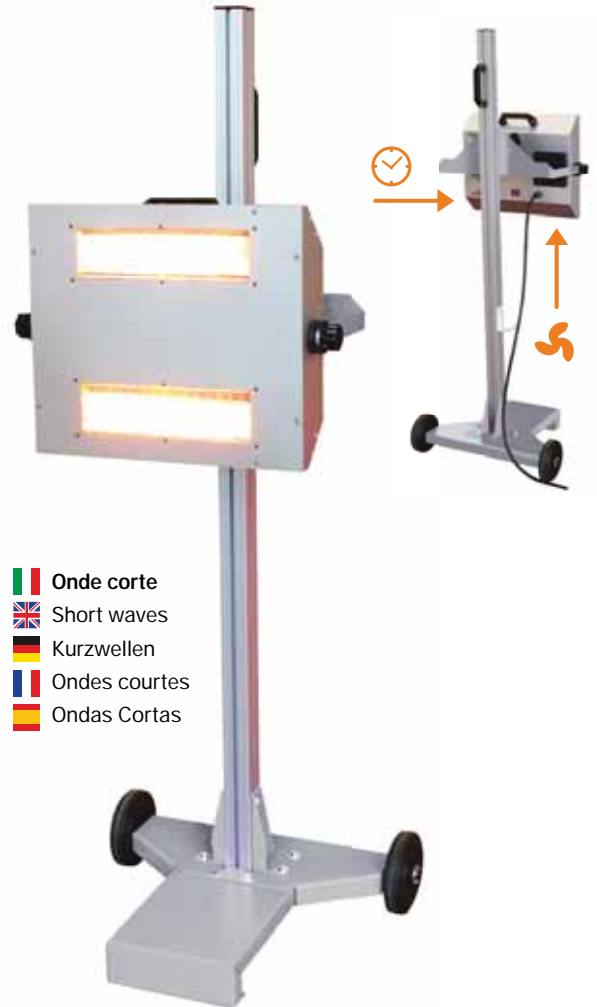

- Onde corte
- Short waves
- Kurzwellen
- Ondes courtes
- Ondas Cortas

DATI TECNICI	COD.	P							MODEL			
010 T	13051550	1 kW	230V 50-60Hz 1P+N+T	10 A	-	-	•	-		600x400 mm	240x465x295H	2,4
015 T	13051590	1,5 kW								900x900 mm	780x500x1600H	20
020 B T	13051680	2 kW										

030 V T

030 V D

030 V DP

- Onde corte
- Short waves
- Kurzwellen
- Ondes courtes
- Ondas Cortas

- Controllo Timer
- Timer control
- Steuerung mit Zeitschaltuhr
- Contrôle avec minuteur
- Control temporizador

- Controllo Digitale
- Digital control
- Steuerung digital
- Contrôle digital
- Control digital



- INFRARED SHORT WAVES DRYER
- MOBILER-INFRAROTSTRAHLER
- SÉCHEUR À INFRAROUGE MOBILE
- SECADOR CON INFRARROJO CON COLUMNA

- Essiccatore ad infrarosso a ONDE CORTE ad alto rendimento
 - Riscaldamento istantaneo, piena potenza entro un secondo dall'accensione
 - Energia pulita: nessun problema di inquinamento causato dall'emissione di raggi infrarossi
 - Controllo a timer oppure DIGITALE con 4 programmi memorizzati
 - Grande manovrabilità della plafoniera
- Very high performance infrared generator
 - Instant heat, full power within one second at switching on
 - Clean energy: no pollution emitted by infrared lamps
 - Timer or digital control with 4 preset programs
 - Wide manoeuvrability of the cassette
- KURZWELLEN-Infrarotstrahler mit hoher Leistung
 - Sofortige Aufwärmung, volle Leistung innerhalb einer Sekunde
 - Saubere Energie: durch die Strahlung entstehen keine Umweltverschmutzungen
 - Steuerung mit Zeitschaltuhr / DIGITAL-Steuerung mit 4 gespeicherten Programmen
 - Große Manövrierfähigkeit des Kassetten
- Sécheur à infrarouge à ONDES COURTES haute efficacité
 - Chaleur instantanée, pleine puissance en 1 seconde
 - Energie propre: aucune pollution environnementale due au rayonnement infrarouge
 - Contrôle avec minuteur / DIGITAL avec 4 programmes mémorisés
 - Grande manœuvrabilité de la cassette
- Secador con infrarrojo con ONDAS CORTAS con alto rendimiento
 - Calentamiento instantáneo, potencia plena pasado un segundo del encendido
 - Energía limpia: ningún problema de contaminación causado por la emisión de rayos infrarrojos
 - Control con temporizador o DIGITAL con 4 programas memorizados
 - Gran maniobrabilidad del plafón

A RICHIESTA 220V 16A MONOFASE 1P+N+T

DATI TECNICI	COD.	P										
030 V T	13052015	3 kW	400V 50-60Hz 3P+T	16 A	-	-	•	-	-		1000 x 1000 mm	780x 500x 1600H
030 V D	13052035		400V 50-60Hz 3P+N+T				•	•				
030 V DP	13052055		•				•					

INFRARED SHORT WAVES WHEELED DRYER WITH 1 CASSETTE
MOBILE INFRAROSTSTRAHLER MIT 1 KASSETTEN
SÉCHEUR À INFRAROUGE 1 CASSETTE AVEC MINUTEUR À ROUES
SECADOR CON INFRARROJO 130 V T MONTADO SOBRE RUEDAS EN 1 PLAFÓN
130 V T
130 V D
130 V DP

- Onde corte**
- Short waves**
- Kurzwellen**
- Ondes courtes**
- Ondas Cortas**



- Controllo Timer**
- Timer control**
- Steuerung mit zeitschaltuhr**
- Contrôle avec minuteur**
- Control temporizador**

- Essiccatore ad infrarosso a ONDE CORTE ad alto rendimento**
 - Riscaldamento istantaneo, piena potenza entro un secondo dall'accensione
 - Energia pulita: nessun problema di inquinamento causato dall'emissione di raggi infrarossi
 - Controllo a timer
 - Grande manovrabilità della plafoniera

- Very high performance infrared generator**
 - Instant heat, full power within one second at switching on
 - Clean energy: no pollution emitted by infrared lamps
 - Timer control
 - Wide manoeuvrability of the cassette

- KURZWELLEN-Infrarotstrahler mit hoher Leistung**
 - Sofortige Aufwärmung, volle Leistung innerhalb einer Sekunde
 - Saubere Energie: durch die Strahlung entstehen keine Umweltverschmutzungen
 - Steuerung mit zeitschaltuhr
 - Große Manövrierfähigkeit des Kassetten

- Sécheur à infrarouge à ONDES COURTES haute efficacité**
 - Chaleur instantanée, pleine puissance en 1 seconde
 - Energie propre: aucune pollution environnementale due au rayonnement infrarouge
 - Contrôle avec minuteur
 - Grande manoeuvrabilité de la cassette

- Secador con infrarrojo con ONDAS CORTAS con alto rendimiento**
 - Calentamiento instantáneo, potencia plena pasado un segundo del encendido
 - Energía limpia: ningún problema de contaminación causado por la emisión de rayos infrarrojos
 - Control con temporizador
 - Gran maniobrabilidad del plafón



- Controllo Digitale**
- Digital control**
- Steuerung digital**
- Contrôle digital**
- Control digital**

A RICHIESTA 220V 16A MONOFASE 1P+N+T

DATI TECNICI	COD.	P							MODEL						
130 V T	13052310	3 kW	400V 50-60Hz 3P+T	16 A	-	-	-	-		1000 x 1000 mm	780x 1100x 1600H	44,5			
130 V D	13052345		400V 50-60Hz 3P+N+T									•	-	-	49,5
130 V DP	13052360		•									-	•	-	

INFRARED SHORT WAVES WHEELED DRYER WITH 2 CASSETTE

MOBILE INFRAROSTSTRAHLER MIT 2 KASSETTEN

SÉCHEUR À INFRAROUGE 2 CASSETTE À ROUES

SECADOR CON INFRARROJO MONTADO SOBRE RUEDAS EN 2 PLAFONES

260 V T
260 V D
260 V DP

- Onde corte
- Short waves
- Kurzwellen
- Ondes courtes
- Ondas Cortas

- Controllo Digitale
- Digital control
- Steuerung digital
- Contrôle digital
- Control digital



- Controllo Timer
- Timer control
- Steuerung mit Zeitschaltuhr
- Contrôle avec minuteur
- Control temporizador

- CONTROLLO TEMPERATURA PER MODELLO "DP"**
- Temperature control for "DP" model
- Temperaturkontrolle für Modell "DP"
- Contrôle température pour modèle "DP"
- Control temperatura para modelo "DP"

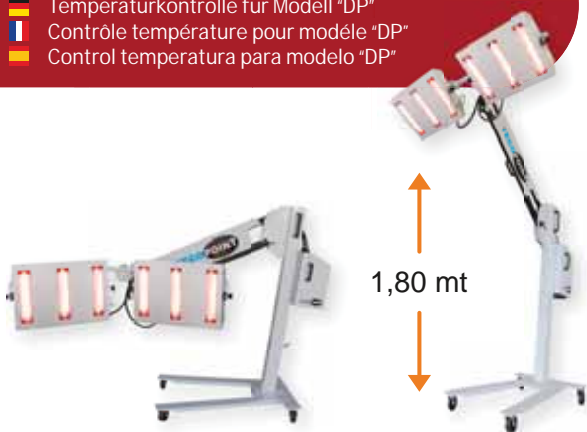

- RIDOTTO INGOMBRO A RIPOSO**

- Space-saving when not working
- Platzsparend bei Nichtverwendung
- Faible encombrement
- Dimensiones máximas reducidas en reposo

- Essiccatore ad infrarosso a ONDE CORTE ad alto rendimento**
- Riscaldamento istantaneo, piena potenza entro un secondo dall'accensione
- Energia pulita: nessun problema di inquinamento causato dall'emissione di raggi infrarossi
- Controllo a timer oppure DIGITALE con 4 programmi memorizzati
- Grande manovrabilità della plafoniera

- Very high performance infrared generator**
- Instant heat, full power within one second at switching on
- Clean energy: no pollution emitted by infrared lamps
- Timer or digital control with 4 preset programs
- Wide manoeuvrability of the cassette

- KURZWELLEN-Infrarotstrahler mit hoher Leistung**
- Sofortige Aufwärmung, volle Leistung innerhalb einer Sekunde
- Saubere Energie: durch die Strahlung entstehen keine Umweltverschmutzungen
- Steuerung mit Zeitschaltuhr / DIGITAL-Steuerung mit 4 gespeicherten Programmen
- Große Manövrierfähigkeit des Kassetten

- Sécheur à infrarouge à ONDES COURTES haute efficacité**
- Chaleur instantanée, pleine puissance en 1 seconde
- Energie propre: aucune pollution environnementale due au rayonnement infrarouge
- Contrôle avec minuteur / DIGITAL avec 4 programmes mémorisés
- Grande manoeuvrabilité de la cassette

- Secador con infrarrojo con ONDAS CORTAS con alto rendimiento**
- Calentamiento instantáneo, potencia plena pasado un segundo del encendido
- Energía limpia: ningún problema de contaminación causado por la emisión de rayos infrarrojos
- Control con temporizador o DIGITAL con 4 programas memorizados
- Gran maniobrabilidad del plafón

DATI TECNICI	COD.	P						MODEL						
260 V T	13052125	6 kW	400V 50-60Hz 3P+T	-	-	-	-		2000 x 1000 mm	1000x 1100x 1600H	64,8			
260 V D	13052145		400V 50-60Hz 3P+N+T								16 A	•	-	73,4
260 V DP	13052152		400V 50-60Hz 3P+T								•	-	•	73,6

INFRARED SHORT WAVES WHEELED DRYER WITH 2 CASSETTE

MOBILE INFRAROSTSTRAHLER MIT 2 KASSETTEN

SÉCHEUR À INFRAROUGE 2 CASSETTE À ROUES

SECADOR CON INFRARROJO MONTADO SOBRE RUEDAS EN 2 PLAFONES

290 V D
290 V DP
290 V DPP

- Controllo Digitale**
- Digital control
- Steuerung digital
- Contrôle digital
- Control digital

- Onde corte**
- Short waves
- Kurzwellen
- Ondes courtes
- Ondas Cortas

- Ridotto Ingombro A Riposo**
- Space-saving when not working
- Platzsparend bei Nichtverwendung
- Faible encombrement
- Dimensiones máximas reducidas en reposo

- CONTROLLO TEMPERATURA PER MODELLO "DP"**
- Temperature control for "DP" model
- Temperaturkontrolle für Modell "DP"
- Contrôle température pour modèle "DP"
- Control temperatura para modelo "DP"

2,05 mt



Essiccatore ad infrarosso a ONDE CORTE ad alto rendimento

- Riscaldamento istantaneo, piena potenza entro un secondo dall'accensione
- Energia pulita: nessun problema di inquinamento causato dall'emissione di raggi infrarossi
- Controllo a timer oppure DIGITALE con 4 programmi memorizzati
- Grande manovrabilità della plafoniera



Very high performance infrared generator

- Instant heat, full power with in one second at switching on
- Clean energy: no pollution emitted by infrared lamps
- Timer or digital control with 4 preset programs
- Wide manoeuvrability of the cassette



KURZWELLEN-Infrarotstrahler mit hoher Leistung

- Sofortige Aufwärmung, volle Leistung innerhalb einer Sekunde
- Saubere Energie: durch die Strahlung entstehen keine Umweltverschmutzungen
- Steuerung mit Zeitschaltuhr / DIGITAL-Steuerung mit 4 gespeicherten Programmen
- Große Manövrierfähigkeit des Kassettes



Sécheur à infrarouge à ONDES COURTES haute efficacité

- Chaleur instantanée, pleine puissance en 1 seconde
- Energie propre: aucune pollution environnementale due au rayonnement infrarouge
- Contrôle avec minuteur / DIGITAL avec 4 programmes mémorisés
- Grande manoeuvrabilité de la cassette



Secador con infrarrojo con ONDAS CORTAS con alto rendimiento

- Calentamiento instantáneo, potencia plena pasado un segundo del encendido
- Energía limpia: ningún problema de contaminación causado por la emisión de rayos infrarrojos
- Control con temporizador o DIGITAL con 4 programas memorizados
- Gran maniobrabilidad del plafón

DATI TECNICI	COD.	P							MODEL				
290 V D	13052505	9 kW	400V 50-60Hz 3P+N+T	16 A	—	—	—	—		2000 x 1000 mm	1000x 1100x 1600H	73,4	
290 V DP	13052510				•	—	—	•				—	73,6
290 V DPP	13052513				2x								

2120 V ST

INDUSTRIA
4.0

INFRARED SHORT WAVES WHEELED DRYER WITH 2 CASSETTE



MOBILE INFRAROSTSTRAHLER MIT 2 KASSETTEN



SÉCHEUR À INFRAROUGE 2 CASSETTE À ROUES



SECADOR CON INFRARROJO MONTADO SOBRE RUEDAS EN 2 PLAFONES



- IMPOSTAZIONE PROGRAMMI CON POSSIBILITÀ DI MEMORIZZARE VALORI A PIACERE**
 Set of programmes-possibility of storing values
 20 Möglichkeiten benutzerdefinierte Programme zu wählen
 Possibilité de mémoriser des valeurs personnalisées
 Configuración de programas con posibilidad de memorizar valores de la manera deseada



- REPORT LAVORO ESEGUITO CON VISUALIZZAZIONE CONSUMO ENERGETICO**
 Report of work done with visual energy consumption
 Bericht der ausgeführten Arbeit mit Anzeige des Energieverbrauchs
 Rapport de travail avec consommation d'énergie visible sur l'écran
 Informe de trabajo realizado con visualización de consumo energético



- CONTROLLO DISTANZA CON SEGNALE ACUSTICO PER ERRORI**
 Distance control with acoustic signal for error
 Abstandkontrolle mit akustischer Fehlermeldung
 Contrôle de distance avec signal acoustique
 Control distancia con señalización acústica por errores



- CONTROLLO DATI IN ESECUZIONE**
 Control data running
 Datenkontrolle läuft
 contrôle données en execution
 Control datos en ejecución



- CONTROLLO TEMPERATURA**
 Temperature control
 Temperaturkontrolle
 Contrôle température
 Control temperatura



- INSERIMENTO TESTO PER PERSONALIZZARE I PROGRAMMI**
 Text entering for programs customization
 Texteingufugung für Programmanpassung
 Insertion de texte pour personnaliser les programmes
 Introducción de texto para personalizar los programas

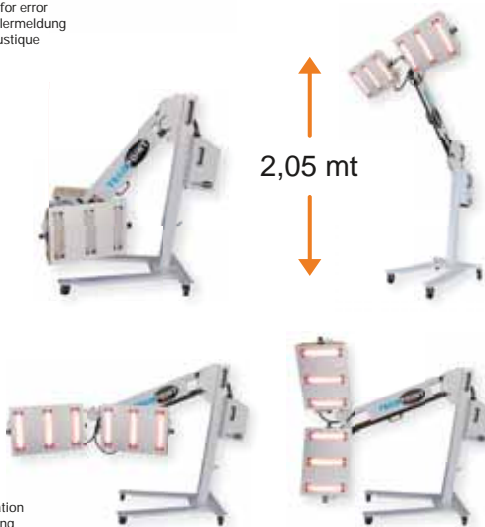

- Ridotto ingombro a riposo**
 Space-saving when not working
 Platzsparend bei Nichtverwendung
 Faible encombrement
 Dimensiones máximas reducidas en reposo

- Onde corte**
 Short waves
 Kurzwellen
 Ondes courtes
 Ondas Cortas

- CONTROLLO TOUCH SCREEN**
 Touch Screen Control
 Touch-Screen Steuerung
 Contrôle Écran Tactile
 Control Pantalla Táctil

- CONTROLLO TEMPERATURA**
 Temperature control
 Temperaturkontrolle
 Contrôle de température
 Control temperatura

- SENSORE DISTANZA**
 Distance Control
 Abstandkontrolle
 Contrôle écran Tactile
 Sensor Distancia

- Essiccatore ad infrarosso a ONDE CORTE ad alto rendimento**
 • Riscaldamento istantaneo, piena potenza entro un secondo dall'accensione
 • Energia pulita: nessun problema di inquinamento causato dall'emissione di raggi infrarossi
 • Controllo TOUCH SCREEN con programmi memorizzati
 • Grande manovrabilità della plafoniera

- Very high performance infrared generator**
 • Instant heat, full power within one second at switching on
 • Clean energy: no pollution emitted by infrared lamps
 • TOUCH SCREEN control
 • Wide manoeuvrability of the cassette

- KURZWELLEN-Infrarotstrahler mit hoher Leistung**
 • Sofortige Aufwärmung, volle Leistung innerhalb einer Sekunde
 • Saubere Energie: durch die Strahlung entstehen keine Umweltverschmutzungen
 • TOUCH-SCREEN Steuerung
 • Große Manövrierfähigkeit des Kassetten

- Sécheur à infrarouge à ONDES COURTES haute efficacité**
 • Chaleur instantanée, pleine puissance en 1 seconde
 • Energie propre: aucune pollution environnementale due au rayonnement infrarouge
 • Afficheur tactile
 • Grande manoeuvrabilité de la cassette

- Secador con infrarrojo con ONDAS CORTAS con alto rendimiento**
 • Calentamiento instantáneo, potencia plena pasado un segundo del encendido
 • Energía limpia: ningún problema de contaminación causado por la emisión de rayos infrarrojos
 • Control PANTALLA TÁCTIL con programas memorizados
 • Gran maniobrabilidad del plafón

DATI TECNICI	COD.	P							MODEL				
2120 V ST	13052270	12 kW	400V 50-60Hz 3P+T	25 A	•	•	—	—	•		2000 x 1000 mm	1000x 1100x 1670H	73,6

2120 GS DP

INFRARED SHORT WAVES WHEELED DRYER WITH 2 CASSETTES LARGE SURFACES
MOBILE INFRAROSTSTRAHLER MIT 2 KASSETTEN GROSSE OBERFLÄCHEN
SÉCHEUR À INFRAROUGE 2 CASSETTE À ROUES GRANDES SURFACES
SECADOR CON INFRARROJO MONTADO SOBRE RUEDAS EN 2 PLAFONES GRANDES



Essiccatore ad infrarosso a ONDE CORTE ad alto rendimento

- Riscaldamento istantaneo, piena potenza entro un secondo dall'accensione
- Energia pulita: nessun problema di inquinamento causato dall'emissione di raggi infrarossi
- Controllo a timer oppure DIGITALE con 4 programmi memorizzati
- Grande manovrabilità della plafoniera

Very high performance infrared generator

- Instant heat, full power within one second at switching on
- Clean energy: no pollution emitted by infrared lamps
- Timer or digital control with 4 preset programs
- Wide manoeuvrability of the cassette

KURZWELLEN-Infrarotstrahler mit hoher Leistung

- Sofortige Aufwärmung, volle Leistung innerhalb einer Sekunde
- Saubere Energie: durch die Strahlung entstehen keine Umweltverschmutzungen
- Steuerung mit Zeitschaltuhr / DIGITAL-Steuerung mit 4 gespeicherten Programmen
- Große Manövrierfähigkeit des Kassetten

Sécheur à infrarouge à ONDES COURTES haute efficacité

- Chaleur instantanée, pleine puissance en 1 seconde
- Energie propre: aucune pollution environnementale due au rayonnement infrarouge
- Contrôle avec minuteur / DIGITAL avec 4 programmes mémorisés
- Grande manœuvrabilité de la cassette

Onde corte

- Short waves
- Kurzwellen
- Ondes courtes
- Ondas Cortas



Controllo Digitale

- Digital control
- Steuerung digital
- Contrôle digital
- Control digital

CONTROLLO TEMPERATURA

- Temperature control
- Temperaturkontrolle
- Contrôle de température
- Control temperatura



3,30 mt

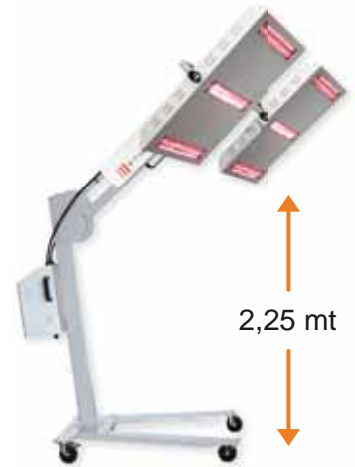

2,25 mt

Secador con infrarrojo con ONDAS CORTAS con alto rendimiento

- Calentamiento instantáneo, potencia plena pasado un segundo del encendido
- Energía limpia: ningún problema de contaminación causado por la emisión de rayos infrarrojos
- Control con temporizador o DIGITAL con 4 programas memorizados
- Gran maniobrabilidad del plafón



GRANDI SUPERFICI 12 kW

- Large surfaces 12 kW
- Große Oberflächen 12 kW
- Grandes superficies 12 kW
- Grandes Superficies 12 kW

DATI TECNICI	COD.	P							MODEL				
2120 GS DP	13052280	12 kW	400V 50-60Hz 3P+N+T	25 A	•	—	—	•	—		2000 x 1400 mm	1000x 1100x 1670H	75

IMS - INFRARED MAGNETIC SYSTEM

IL NUOVO CONCETTO DI MODULARITÀ Pratico per tutti i lavori Spot Repair.

The new concept of modularity. Perfect for spot repair.



OPTIONAL
Abilitazione sistema IMS
da quadro elettrico
tramite 24 VDC



MAGNETIC

Grazie alle clip magnetiche di cui sono dotati i moduli infrarosso, possono essere spostati lungo la parete della cabina all'altezza desiderata, inclinati per irradiare uniformemente anche le superfici curve.

Thanks to the magnetic clips, the infrared heads can be moved along the wall of the spraybooth in whatever position and oriented to radiate uniformly even the curved surfaces.



NELLA TUA CABINA L'INFRAROSSO MIRATO DOVE SERVE
Infrared just where you need it in your spraybooth



- Copertura protezione plafoniera
- Cover protection for cassette
- Schutzabdeckung Lichtkasten
- Couverture protection cassette
- Tapa protección tapón

590 V DP

590 V ST

5120 GS DP

5120 GS ST



INDUSTRIA
4.0



INDUSTRIA
4.0

OVERHEAD SLIDING SYSTEM
 SYSTEM MIT ÜBERKOPFVERSCHIEBUNG
 SYSTÈME À GLISSEMENT AÉRIEN
 SISTEMA CON DESPLAZAMIENTO AÉREO



GS



- Vista di un sistema a scorrimento aereo standard. Per accessori vedere le pagine successive.
- Overhead sliding standard system. See the following pages for accessories
- Ansicht eines Standardsystems mit Überkopferschiebung. Für das Zubehör, die folgenden Seiten konsultieren
- Vue d'un système à glissement aérien standard. Pour les accessoires, voir les pages suivantes
- Vista de un sistema con desplazamiento aéreo estándar. Para accesorios, véanse las siguientes páginas.





- Controllo DP (DIGITALE con PIROMETRO)**
- DP (Digital with Pyrometer) Control
- Système à glissement latéral
- Contrôle "DP" (NUMÉRIQUE avec PYROMÈTRE)
- Sistema con desplazamiento lateral

- Controllo ST (touch screen con Pirometro e sensore di distanza)**
- ST (touch screen control - pyrometer distance sensor)
- Kontrolle ST (Touch Screen mit Pyrometer und Distanzsensor)
- Contrôle ST (touch screen avec Pyromètre et capteur de distance)
- Control ST (pantalla táctil con Pirómetro y sensor de distancia)

DATI TECNICI	COD.	P							MODEL					
590 V DP	•	9 kW	400V 50-60Hz 3P+N+T	•	—	—	•	—		2000 x 1000 mm	—	—		
590 V ST	•				•		•							
5120 GS DP	•	12 kW			—		•	—	•	—				2000 x 1400 mm
5120 GS ST	•				•		•							

5120 STM TRIO

MOTORIZED SYSTEM FOR PAINT DRYING



MOTORISIERTES SYSTEM ZUR LACKTROCKNUNG



SYSTÈME MOTORISÉ POUR LE SÉCHAGE DES PEINTURES



SISTEMA MOTORIZADO 5120 STM TRIO PARA SECADO DE BARNICES



FIGURA 1 Pag. 32



FIGURA 2 Pag. 32



FIGURA 3 Pag. 32

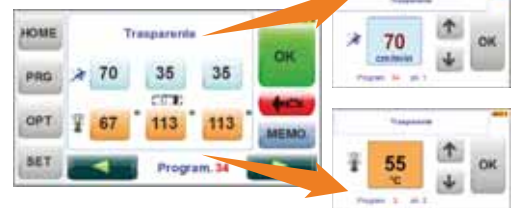

- Controllo STR con touch screen e movimento con motore inverter - pirometro**
- STR control touch screen control - movement with inverter engine pyrometer**
- Kontrolle STR, Kontrolle Touch Screen und Bewegung mit Invertermotor - Pyrometer**
- Contrôle STR contrôle tactile et mouvement avec moteur onduleur - pyromètre**
- Control STR control pantalla táctil y movimiento con motor inverter - pirómetro**

Controllo STR TRIO
L'essiccatore si posiziona sulle aree selezionate oggetto di trattamento (in verde), ed attiva l'irradiazione. Le aree grigie, non soggette al trattamento, sono quindi passate a plafoniere spente evitando inutili sprechi di energia.

STR TRIO control
The emitter moves automatically on the selected areas (green panels) and activates the cassettes. The grey zones (panels switched off), not involved in the process, are therefore bypassed so to allow to save energy.





Kontrolle STR TRIO
Der Trockner positioniert sich über den für die Behandlung ausgewählten Bereichen (in grün) und aktiviert die Bestrahlung. Die grauen Bereiche, die nicht der Behandlung unterzogen werden, werden mit ausgeschalteten Lichtkästen überquert, wodurch eine unnötige Energieverschwendung vermieden wird.











Contrôle STR TRIO
Le sècheur se place sur les zones sélectionnées faisant l'objet du traitement (en vert), et active le rayonnement. Les zones grises, qui ne font pas l'objet du traitement, sont donc passées avec les cassettes éteintes en évitant ainsi de gaspillages inutiles d'énergie

Control STR TRIO
El secador se coloca en las zonas seleccionadas objeto de tratamiento (en verde) y activa la irradiación. Las zonas grises, no sujetas al tratamiento, han pasado, por lo tanto, con plafones apagados, evitando derroches de energía inútiles.



MOTORIZZATO

-  Possibilità di snodo del sistema TRIO
-  Range of movement of the "TRIO" system
-  Möglichkeit der Verbindung des Systems TRIO
-  Possibilité d'articulation du système TRIO
-  Posibilidad de articulación del sistema TRIO

DATI TECNICI	COD.	P							MODEL	 mm	 mm	 KG
5120 STM TRIO	•	12 kW	400V 50-60Hz 3P+N+T	•	•	-	-	•		-	-	-

6120 STM TETRA MM

ROBOTIC SYSTEM FOR PAINT DRYING
 ROBOTERSYSTEM FÜR LACKTROCKNUNG
 SYSTÈME ROBOTISÉ POUR LE SÈCHAGE DES PEINTURES
 SISTEMA ROBOTIZADO PARA SECADOS DE BARNICES

Gli essiccatori motorizzati 6120 STM rappresentano la più avanzata tecnologia per il controllo delle sorgenti di radiazione infrarossa per essiccazione delle vernici.

The motorized dryers 6120 STM represent the most advanced technology for controlling the sources of infrared radiation for paint drying.

Die motorisierten Lackrockner 6120 STM stellen die höchstentwickeltste Technologie für die Kontrolle von Quellen von Infrarotstrahlung zur Lacktrocknung dar.

Les sècheurs motorisés 6120 STM représentent la technologie la plus avancée pour le contrôle des sources de rayonnement infrarouge pour le séchage des peintures.

Los secadores motorizados 6120 STM representan la tecnología más avanzada para el control de las fuentes de radiación infrarroja para el secado de los barnices.

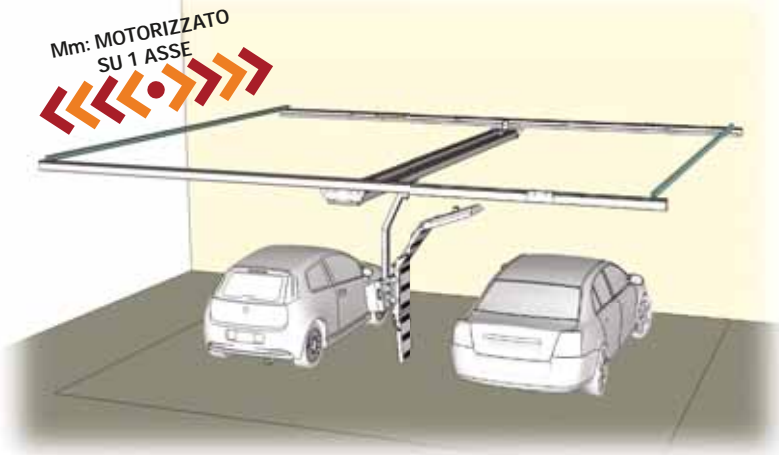

Controllo 6120 STM touch screen e movimento con motore inverter - pirometro

6120 STM control, touch screen movement with inverter engine pyrometer

Kontrolle 6120 STM, Touch Screen und Bewegung mit Invertermotor - Pyrometer

Contrôle 6120 STM, tactile et mouvement avec moteur onduleur – pyromètre

Control 6120 STM, pantalla táctil y movimiento con motor inverter - pirómetro



DATI TECNICI	COD.	P							MODEL				
6120 STM TETRA Mm	•	12 kW	400V 50-60Hz 3P+N+T	25 A	3x	•	—	—	•		—	—	—

6120 STM TETRA Bm

ROBOTIC SYSTEM FOR PAINT DRYING
 ROBOTERSYSTEM FÜR LACKTROCKNUNG
 SYSTÈME ROBOTISÉ POUR LE SÈCHAGE DES PEINTURES
 SISTEMA ROBOTIZADO PARA SECADOS DE BARNICES



Bm: MOTORIZZATO SU 2 ASSI



FIGURA 1 Pag. 32



FIGURA 3 Pag. 32

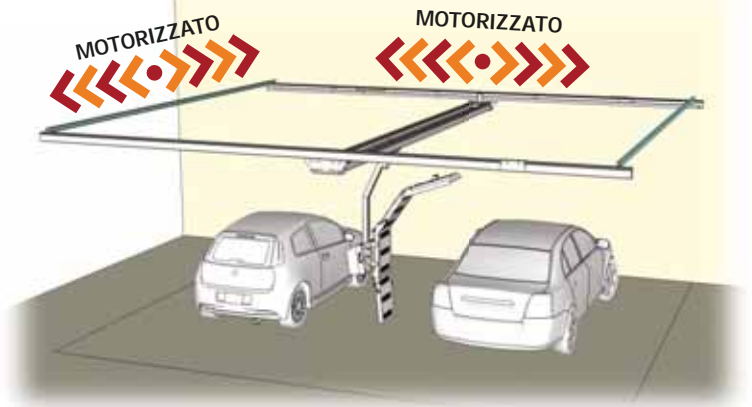

STATISTICS

DATI TECNICI	COD.	P											
6120 STM TETRA Bm	•	12 kW	400V 50-60Hz 3P+N+T	25 A	3x	•	-	-	•		-	-	-

7300 STR

7330 STR



INDUSTRIA
4.0



ROBOTIC SYSTEM FOR PAINT DRYING

ROBOTERSYSTEM FÜR LACKTROCKNUNG

SYSTÈME ROBOTISÉ POUR LE SÉCHAGE DES PEINTURES

SISTEMA ROBOTIZADO PARA SECADOS DE BARNICES



STR

IT Gli essiccatori motorizzati 7000/STR IRSolutions rappresentano la più avanzata tecnologia per il controllo delle sorgenti di radiazione infrarossa per essiccazione delle vernici.

UK The motorized dryers 7000/STR IRSolutions represent the most advanced technology for controlling the sources of infrared radiation for paint drying.

DE Die motorisierten Lacktrockner 7000/STR IRSolutions stellen die höchstentwickeltste Technologie für die Kontrolle von Quellen von Infrarotstrahlung zur Lacktrocknung dar.

FR Les sècheurs motorisés 7000/STR IRSolutions représentent la technologie la plus avancée pour le contrôle des sources de rayonnement infrarouge pour le séchage des peintures.

ES Los secadores motorizados 7000/STR IRSolutions representan la tecnología más avanzada para el control de las fuentes de radiación infrarroja para el secado de los barnices.



- IT** Controllo STR controllo touch screen e movimento con motore inverter - pirometro
- UK** STR control touch screen control – movement with inverter engine pyrometer
- DE** Kontrolle STR, Kontrolle Touch Screen und Bewegung mit Invertermotor - Pyrometer
- FR** Contrôle STR contrôle tactile et mouvement avec moteur onduleur – pyromètre
- ES** Control STR control pantalla táctil y movimiento con motor inverter - pirómetro

CONTROLLO STR
L'essiccatore si posiziona sulle aree selezionate oggetto di trattamento (in verde), ed attiva l'irradiazione. Le aree grigie, non soggette al trattamento, sono quindi passate a plafoniere spente evitando inutili sprechi di energia.

STR control
The emitter moves automatically on the selected areas (green panels) and activates the cassettes. The grey zones (panels switched off), not involved in the process, are therefore bypassed so to allow to save energy.

Kontrolle STR
Der Trockner positioniert sich über den für die Behandlung ausgewählten Bereichen (in grün) und aktiviert die Bestrahlung. Die grauen Bereiche, die nicht der Behandlung unterzogen werden, werden mit ausgeschalteten Lichtkästen überquert, wodurch eine unnötige Energieverschwendung vermieden wird.

Contrôle STR
Le sécheur se place sur les zones sélectionnées faisant l'objet du traitement (en vert), et active le rayonnement. Les zones grises, qui ne font pas l'objet du traitement, sont donc passées avec les cassettes éteintes en évitant ainsi de gaspiller inutilement l'énergie.

Control STR
El secador se coloca en las zonas seleccionadas objeto de tratamiento (en verde) y activa la irradiación. Las zonas grises, no sujetas al tratamiento, han pasado, por lo tanto, con plafones apagados, evitando derroches de energía inútiles.

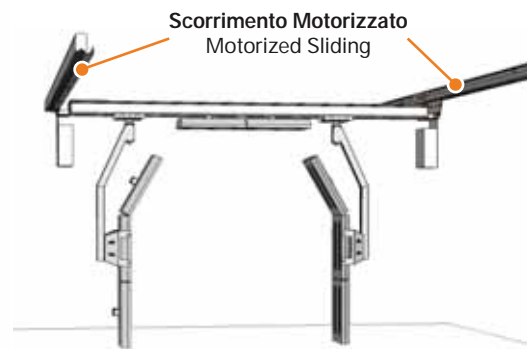

- Posizionamento manuale della larghezza**
- Manual width adjustment
- Manuelle Positionierung der Länge
- Réglage de largeur manuelle
- Posicionamiento manual de la anchura

Rotazione automatica -45° +45°
Automatic rotation -45° +45°



FIGURA 1 Pag. 32



FIGURA 3 Pag. 32

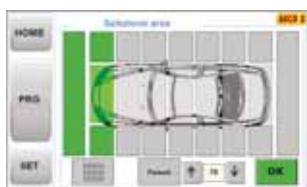

STATISTICS

DATI TECNICI	COD.	P										
7300 STR	•	30 kW	400V 50-60Hz 3P+N+T	3x	-	-	-	•		-	-	-
7300 STR	•	33 kW										



Gli essiccatori motorizzati 5120 STM TRIO IRSolutions rappresentano la più avanzata tecnologia per il controllo delle sorgenti di radiazione infrarossa per essiccazione delle vernici¹. Il controllo del processo di essiccazione avviene tramite un insieme di sensori, che forniscono informazioni ad un dispositivo programmabile; tramite un programma residente in memoria gestisce l'automazione del processo controllando un insieme di attuatori che concretizzano il funzionamento voluto. L'interfaccia uomo macchina è costituita da un dispositivo di tipo touch screen mediante il quale si ha il totale controllo del processo di essiccazione. L'operatore deve semplicemente selezionare il programma (che dipende dal tipo di vernice, dalla superficie ecc.), le zone da trattare ed avviare la macchina che a questo punto inizia il trattamento. Il processo di essiccazione è completamente automatico ma, per completezza, va detto che per garantire la sicurezza del lavoro e la qualità assoluta dello stesso, il sistema è dotato di un insieme di messaggi visivo/sonori che vengono attivati laddove sia necessario l'intervento da parte dell'operatore nonché per segnalare la fine programma.

Riportiamo di seguito le principali caratteristiche del sistema:

- posizionamento del carro mediante l'utilizzo del motore. (figura 1);
- L'essiccatore si posiziona sulle aree selezionate oggetto di trattamento (in verde), ed attiva l'irradiazione. Le aree grigie, non soggette al trattamento, sono quindi passate a plafoniere spente evitando inutili sprechi di energia. (figura 2)
- completo controllo del processo di essiccazione (figura 3):- temperatura della superficie da essiccare – il software garantisce il raggiungimento della temperatura di essiccazione in modo graduale evitando inutili e dannosi shock termici del supporto e della vernice;
- Visualizzazione della velocità di esecuzione del lavoro
- visualizzazione della posizione delle plafoniere e della fase di lavoro corrente;
- supporto multilingue.

¹ Rimandiamo alla Relazione Energy Using Products la descrizione completa delle caratteristiche degli essiccatori IRSolutions



The motorized dryers 5120 STM TRIO IRSolutions represent the most advanced technology for controlling the sources of infrared radiation for curing¹. The drying process control takes place through a set of sensors, which provide information to a programmable device; a touch screen control allows the complete regulation of the drying process. The operator has only to choose the program (depending on paint, surface etc.) and to select the areas to treat and switch on the device that will begin to work in the best way. The drying process is completely automatic and is equipped with acoustics/visual signals for warning the operator if necessary.

The main features of 7180/str are :

- The motorized movement
- The possibility to position on the areas to be treated
- The complete control of the drying process:
- The best temperature of the drying surface avoiding thermal chocs that could damage the surface and the paint
- Work speed control on the touch screen
- Cassette position control on the touch screen
- Multilingual panel

¹ Rimandiamo alla Relazione Energy Using Products la descrizione completa delle caratteristiche degli essiccatori IRSolutions



Die motorisierten Lacktrockner 5120 STM TRIO IRSolutions stellen die höchstentwickelte Technologie für die Kontrolle von Quellen von Infrarotstrahlung zur Lacktrocknung dar¹. Die Kontrolle des Trocknungsprozesses erfolgt mittels eines Zusammenspiels von Sensoren, die einem programmierbaren Gerät Informationen liefern; über ein gespeichertes Programm regelt das Gerät die Automatisierung des Prozesses, wobei das Zusammenspiel von Aktuatoren kontrolliert wird, die das gewünschte Funktionieren herstellen.

Die Mensch-Maschine-Schnittstelle besteht aus einem Gerät mit Touch Screen über das man die vollständige Kontrolle über den Trocknungsprozess hat. Der Bediener muss lediglich das Programm (welches von der Lackart, der Oberfläche etc. abhängt) und die zu behandelnden Bereiche auswählen und die Maschine starten, die dann mit der Bearbeitung anfängt. Der Trocknungsprozess ist vollständig automatisch aber, der Vollständigkeit halber muss gesagt werden, dass das System zur Garantie der Sicherheit der Arbeit und der absoluten Qualität derselben mit einem Zusammenspiel von visuellen und akustischen Signalen ausgestattet ist, die aktiviert werden, wenn ein Einsatz des Bedieners notwendig ist, sowie, um das Programmieren anzuzeigen.

Nachfolgend stellen wir die wesentlichen Eigenschaften des Systems dar:
Positionieren des Schlittens mittels Verwendung des Motors. (Abbildung 1);

Der Trockner positioniert sich über den für die Behandlung ausgewählten Bereichen (in grün) und aktiviert die Bestrahlung. Die grauen Bereiche, die nicht der Behandlung unterzogen werden, werden mit ausgeschalteten Lichtkästen überquert, wodurch eine unnötige Energieverschwendung vermieden wird. (Abbildung 2);

- Vollständige Kontrolle des Trocknungsprozesses (Abbildung 3):
- Temperatur der zu trocknenden Oberfläche – die Software garantiert das Erreichen der Trockentemperatur auf graduelle Weise, wodurch unnötige und schädliche Thermoschocks des Materials und des Lacks vermieden werden;
- Anzeige der Geschwindigkeit der Arbeitsausführung
- Anzeige der Position der Lichtkästen und aktuellen Arbeitsphase;
- mehrsprachige Unterstützung.

¹ Für eine vollständige Beschreibung der Eigenschaften der IRSolutions-Lacktrockner verweisen wir auf die Relazione Energy Using Products



Les sècheurs motorisés 5120 STM TRIO IRSolutions représentent la technologie la plus avancée pour le contrôle des sources de rayonnement infrarouge pour le séchage des peintures¹. Le contrôle du processus de séchage se fait grâce à un ensemble de capteurs qui fournissent des informations à un dispositif programmable ; le programme se trouvant dans la mémoire gère l'automatisation du processus en contrôlant un ensemble d'actionneurs qui concrétisent le fonctionnement souhaité. L'interface homme machine se compose d'un dispositif tactile qui permet d'avoir le contrôle total du processus de séchage. L'opérateur doit simplement sélectionner le programme (qui dépend du type de peinture, de la surface, etc.), les zones à traiter et démarrer la machine qui commence alors le traitement. Le processus de séchage est totalement automatique mais, pour être exhaustif, il faut signaler que, pour garantir la sécurité du travail et la qualité absolue, le système est doté d'un ensemble de messages visuels/sonores qui s'activent lorsque l'opérateur doit intervenir ou pour signaler la fin du programme.

Nous indiquons ci-après les caractéristiques principales du système :

- positionnement du chariot en utilisant le moteur. (figure 1) ;
- Le sècheur se place sur les zones sélectionnées faisant l'objet de traitement (en vert), et active le rayonnement. Les zones grises, qui ne font pas l'objet de traitement, sont donc passées avec les cassettes éteintes en évitant ainsi de gaspillages inutiles d'énergie. (figure 2)
- contrôle complet du processus de séchage (figure 3) ;
- température de la surface à sécher – le logiciel donne la garantie d'atteindre la température de séchage de façon progressive en évitant des chocs thermiques inutiles et dommageables du support et de la peinture ;
- Affichage de la vitesse d'exécution du travail
- affichage de la position des cassettes et de la phase de travail courante ;
- support multilingue.

¹ Nous renvoyons au Rapport Energy Using Products pour la description complète des caractéristiques des sècheurs IRSolutions



Los secadores motorizados 5120 STM TRIO IRSolutions representan la tecnología más avanzada para el control de las fuentes de radiación infrarroja para el secado de los barnices¹. El control del proceso de secado se produce mediante un conjunto de sensores, que dan informaciones a un dispositivo programable; mediante un programa residente en la memoria gestión la automatización del proceso controlando un conjunto de actuadores que concretizan el funcionamiento deseado. La interfaz hombre está formada por un dispositivo de tipo pantalla táctil mediante el cual se tiene un control total del proceso de secado. El operador solamente tiene que seleccionar el programa (que depende del tipo de barniz, de la superficie, etc.), las zonas a tratar y poner en marcha la máquina que, en este punto, empieza el tratamiento. El proceso de secado es completamente automático, pero, para ser precisos, se dice que, para garantizar la seguridad del trabajo y la calidad absoluta del mismo, el sistema está provisto de un conjunto de mensajes visuales/sonoros que se activan en donde es necesaria la intervención por parte del operador, así como para señalar el final del programa.

A continuación, indicamos las características principales del sistema:

- posicionamiento del carro mediante el uso del motor. (figura 1);
- El secador se coloca en las zonas seleccionadas objeto de tratamiento (en verde) y activa la irradiación. Las zonas grises, no sujetas al tratamiento, han pasado, por lo tanto, con plafones apagados, evitando derroches de energía inútiles. (figura 2)
- control completo del proceso de secado (figura 3):- temperatura de la superficie a secar – el software garantiza que se alcance la temperatura de secado de manera gradual evitando choques térmicos inútiles y dañinos del soporte y del barniz;
- Visualización de la velocidad de ejecución del trabajo
- visualización de la posición de los plafones y de la fase de trabajo actual;
- soporte multilingüe

¹ Remitimos al Informe Energy Using Products (Productos que usan energía) para la descripción completa de las características de los secadores IRSolutions



Solo le aree verdi sono oggetto di trattamento. L'essiccatore si posiziona in automatico su di esse attivando l'irradiazione. Le aree grigie sono invece escluse; l'essiccatore le scorre alla massima velocità ed a plafoniere spente evitando inutili sprechi di energia ed ottimizzando il tempo di utilizzo dell'impianto.



- Only the green areas shall be treated. The dryer automatically activates the irradiation on these areas. The grey areas are excluded; the dryer bypasses them at the maximum speed with the cassettes off, so to avoid unnecessary energy consumption and optimizing the operating time.



- Nur die grünen Bereiche sind Gegenstand der Bearbeitung. Der Trockner positioniert sich automatisch über diese Bereiche und beginnt mit der Bestrahlung. Die grauen Bereiche sind hingegen ausgeschlossen; der Trockner überquert sie mit maximaler Geschwindigkeit mit ausgeschalteten Lichtkästen, wodurch eine unnötige Energieverschwendung vermieden und die Nutzungszeit der Anlage optimiert wird.



- Seules les zones vertes font l'objet de traitement. Le sècheur se place sur ces zones en activant le rayonnement. En revanche, les zones grises sont exclues : le sècheur passe dessus à la vitesse maximale et avec les cassettes éteintes en évitant ainsi de gaspillages inutiles d'énergie et en optimisant le temps d'utilisation de l'installation



- Solamente las zonas verdes son objeto de tratamiento. El secador se posiciona automáticamente sobre las zonas activando la irradiación. En cambio, las zonas grises están excluidas; el secado lo desplaza a la máxima velocidad y con los plafones apagados evitando derroches inútiles de energía y optimizando el tiempo de uso de la instalación.



L'utilizzatore può cambiare a piacere i parametri (velocità, temperatura, tempo), di ciascun programma. Il tasto MEMO permette di memorizzare i programmi personalizzando anche il nome; la macchina conserva i programmi memorizzati anche da spenta.



- The user can change the programs parameters at his choice (speed, temperature, time).

A memo key allows you to store programs by customizing even the name; the device keeps the programs also when switched off.



- Der Benutzer kann die Parameter von jedem Programm je nach Wunsch verändern (Geschwindigkeit, Temperatur, Zeit). Die Taste MEMO ermöglicht es, die Programme zu speichern, wobei man auch den Namen verändern kann; die Maschine konserviert die gespeicherten Programme auch, wenn sie ausgeschaltet ist.



- L'utilisateur peut modifier à volonté les paramètres (vitesse, température, temps) de chaque programme. La touche MEMO permet de mémoriser les programmes en en personnalisant même le nom ; la machine conserve les programmes mémorisés même lorsqu'elle est éteinte.



- El usuario puede cambiar según desee los parámetros (velocidad, temperatura, tiempo), de cada programa. La tecla MEMO permite memorizar los programas personalizando incluso el nombre; la máquina conserva los programas memorizados, incluso apagada.

TECOPPOINT[®]



NOVITÀ

**LA PRIMA LAMPADA
CARRELLATA A BATTERIA**

ULED 0.800 BAT

Cod. 13062190

UV CURING

UV-STRALUNGSTROCKNER

SÉCHEURS RADIANTS À SPECTRE ULTRAVIOLET

LÁMPARA LCCL-200 PARA SECADO CON LUZ ULTRAVIOLETA

LCCL-200 BAT

Fucciola UV-A LED

P = 540 mW/cm^{2*}



LCCL-SLIM-800 BAT

Fucciola UV-A LED

P = 620 mW/cm^{2*}



LCCL-400 BAT

Fucciola UV-A LED

P = 920 mW/cm^{2*}



LCCL-8000 BAT

Fucciola UV-A LED

P = 1160 mW/cm^{2*}



I prodotti ad essiccazione Ultravioletta rappresentano il massimo livello tecnologico raggiunto nel settore dei prodotti vernicianti. Il processo di essiccazione è attivato istantaneamente dall'energia presente nei raggi ultravioletti inviati sulla superficie.

Ultraviolet-cured coatings represent the maximum technological level in the field of paints and varnishes. The drying process is instantaneously activated by the energy of the ultraviolet rays sent on the surface.

Die UV-Trocknungsgeräte stellen das technologische Spitzenniveau der Lackierproduktebranche dar. Der Trocknungsprozess wird unmittelbar durch die in den UV-Strahlen vorhandene Energie, die auf die Oberfläche übertragen wird, aktiviert.

Les produits à séchage ultraviolet représentent le niveau technologique maximum atteint dans le secteur des produits de revêtement. Le processus de séchage est activé instantanément par l'énergie présente dans les rayons ultraviolets envoyés sur la surface.

Los productos con secado Ultravioleta representan el nivel tecnológico máximo alcanzado en el sector de los productos de barnizado. El proceso de secado es activado al instante por la energía presente en los rayos ultravioletas enviados en la superficie.



OPTIONAL

Art. 13051510

- Piedistallo piantana
- Stand
- Säule
- Pilier
- Pedestal poste

OPTIONAL
Art.13090266
MAGNETIC KIT



LED

- Controllo digitale
- Digital control
- Steuerung digital
- Contrôle digital
- Control digital

DATI TECNICI	LccL - 200 BAT COD. 13062770		LccL - 400 BAT COD. 13062772		LccL-8000 BAT COD. 13062785		LccL-SLIM-800 BAT COD. 13062776		
LED ad alta potenza, lunghezza d'onda di picco High-power LEDs, peak wavelength	8 LED Multipli/multiples		16 LED Multipli/multiples		32 LED Multipli/multiples		32 LED Multipli/multiples		UVA 395 nm
Tensione di alimentazione caricabatteria • Battery charger power supply	200-250 V 50-60 Hz								
Tensione di alimentazione LccL • LccL Supply voltage	18 V DC								
Batteria ricaricabile • Rechargeable battery	Li-Ion 18 V DC 4000 mAh o 2500 mAh								
Controllo della tensione in uscita per garantire sempre la corretta emissione UV. Output voltage control	SI/YES								
* Potenza emessa UVA* (distanza circa 10 cm)** UVA power (distance about 10 cm)**	≈ 540		≈ 920		≈ 1160		≈ 620		mW/cm ²
Superficie di irraggiamento approssimativa (distanza 10 cm) Approximate curing surface (distance 10 cm)	19 x 16		19 x 19		24 x 19		48 x 16		cm
Temperatura di esercizio ottimale • Optimal operating temperature	+15 ÷ +35		+15 ÷ +35		+15 ÷ +35		+15 ÷ +35		°C
Batteria • Battery	2500	4000	2500	4000	2500	4000	2500	4000	mAh
Peso della batteria • Battery weight	0,460	0,670	0,460	0,670	0,460	0,670	0,460	0,670	kg
Tempo utile di essiccazione • Useful drying time	30	60	21	30	10	15	10	15	minuti/minutes
Peso senza batteria • Weight without battery	1,345		1,516		1,880		2,280		kg
Altezza x lunghezza x larghezza (misure indicative senza batteria) Height x length x width (rough measurements without battery)	235 x 120 x 180		235 x 120 x 180		340 x 120 x 170		475 x 120 x 135		mm
L'apparecchiatura comprende (** a seconda della confezione di acquisto) The equipment includes (** depending on the purchase package)									
LccL, 1 batteria(*), high speed charger, occhiali di protezione UV, seconda batteria opzionale(*) LccL, 1 battery (*), high speed charger, UV glasses, optional second battery (*)									

**Measured by LS125 detector

LCCL-200

Lucciola UV-A LED

LCCL-400

Lucciola UV-A LED

UV CURING



UV-STRALUNGSTROCKNER



SÉCHEURS RADIANTS À SPECTRE ULTRAVIOLET



LÂMPARA LCCL-200 PARA SECADO CON LUZ ULTRAVIOLETA



LED

- Controllo digitale**
- Digital control**
- Steuerung digital**
- Contrôle digital**
- Control digital**



LCCL-SLIM-800

Lucciola UV-A LED



I prodotti ad essiccazione Ultravioletta rappresentano il massimo livello tecnologico raggiunto nel settore dei prodotti vernicianti. Il processo di essiccazione è attivato istantaneamente dall'energia presente nei raggi ultravioletti inviati sulla superficie.



Ultraviolet-cured coatings represent the maximum technological level in the field of paints and varnishes. The drying process is instantaneously activated by the energy of the ultraviolet rays sent on the surface.



Die UV-Trocknungsgeräte stellen das technologische Spitzenniveau der Lackierproduktebranche dar. Der Trocknungsprozess wird unmittelbar durch die in den UV-Strahlen vorhandene Energie, die auf die Oberfläche übertragen wird, aktiviert.



Les produits à séchage ultraviolet représentent le niveau technologique maximum atteint dans le secteur des produits de revêtement. Le processus de séchage est activé instantanément par l'énergie présente dans les rayons ultraviolets envoyés sur la surface.



Los productos con secado Ultravioleta representan el nivel tecnológico máximo alcanzado en el sector de los productos de barnizado. El proceso de secado es activado al instante por la energía presente en los rayos ultravioletas enviados en la superficie.

DATI TECNICI	COD.	P							MODEL			
LCCL-200	13062820	—	230V 50-60Hz 2,6 A	—	—	—	•	—	UVA LED	↔ 100mm = MANUALE	—	2,6
LCCL-400	13062825	—	230V 50-60Hz 2P+T	—	—	—	•	—	UVA LED	↔ 100mm = MANUALE	—	3,3
LCCL-SLIM-800	13062840	—	230V 50-60Hz 2P+T	—	—	—	•	—	UVA LED	↔ 100mm = MANUALE	—	1,95 + 1,70

ULED 0.800

UV CURING

UV-STRALUNGSTROCKNER

SÉCHEURS RADIANTS À SPECTRE ULTRAVIOLET

LÁMPARA LCCL-200 PARA SECADO CON LUZ ULTRAVIOLETA

- Controllo digitale
- Digital control
- Steuerung digital
- Contrôle digital
- Control digital

ULED 0.1200

- Controllo digitale
- Digital control
- Steuerung digital
- Contrôle digital
- Control digital

- Predisposizione per LUCCIOLA UV-A
- Suitable for LUCCIOLA UV-A
- Arrangiert für LUCCIOLA UV-A
- Adapté pour LUCCIOLA UV-A
- Arreglado para LUCCIOLA UV-A

OPTIONAL
LUCCIOLA UV-A

LED

LED

UV-A

I prodotti ad essiccazione Ultravioletta rappresentano il massimo livello tecnologico raggiunto nel settore dei prodotti vernicianti. Il processo di essiccazione è attivato istantaneamente dall'energia presente nei raggi ultravioletti inviati sulla superficie.



Ultraviolet-cured coatings represent the maximum technological level in the field of paints and varnishes. The drying process is instantaneously activated by the energy of the ultraviolet rays sent on the surface.

Die UV-Trocknungsgeräte stellen das technologische Spitzenniveau der Lackierproduktebranche dar. Der Trocknungsprozess wird unmittelbar durch die in den UV-Strahlen vorhandene Energie, die auf die Oberfläche übertragen wird, aktiviert.

Les produits à séchage ultraviolette représentent le niveau technologique maximum atteint dans le secteur des produits de revêtement. Le processus de séchage est activé instantanément par l'énergie présente dans les rayons ultraviolets envoyés sur la surface.

Los productos con secado Ultravioleta representan el nivel tecnológico máximo alcanzado en el sector de los productos de barnizado. El proceso de secado es activado al instante por la energía presente en los rayos ultravioletas enviados en la superficie.

DATI TECNICI	COD.	P							MODEL				
ULED 0.1200	13062210	UV LED	230V 50-60Hz 2P+T	5,3 A	-	-	-	•	-	UVA LED	↔ 350 mm	780x 500x 1600H	68,2
										UV - LED	650x850 mm		
ULED 0.800	13062205			2,8 A						UVA LED	↔ 350 mm		20,6
										UV - LED	500x500 mm		

ULED 2.1200

UV CURING



UV-STRALUNGSTROCKNER



SÈCHEURS RADIANTS À SPECTRE ULTRAVIOLET



LÁMPARA LCCL-200 PARA SECADO CON LUZ ULTRAVIOLETA



UV-A {

- Controllo digitale**
- Digital control
- Steuerung digital
- Contrôle digital
- Control digital

Predisposizione per LUCCIOLA UV-A

- Suitable for LUCCIOLA UV-A
- Arrangiert für LUCCIOLA UV-A
- Adapté pour LUCCIOLA UV-A
- Arreglado para LUCCIOLA UV-A



**OPTIONAL
LUCCIOLA UV-A**



LED



I prodotti ad essiccazione Ultravioletta rappresentano il massimo livello tecnologico raggiunto nel settore dei prodotti vernicianti. Il processo di essiccazione è attivato istantaneamente dall'energia presente nei raggi ultravioletti inviati sulla superficie.

Ultraviolet-cured coatings represent the maximum technological level in the field of paints and varnishes. The drying process is instantaneously activated by the energy of the ultraviolet rays sent on the surface.

Die UV-Trocknungsgeräte stellen das technologische Spitzenniveau der Lackierproduktebranche dar. Der Trocknungsprozess wird unmittelbar durch die in den UV-Strahlen vorhandene Energie, die auf die Oberfläche übertragen wird, aktiviert.

Les produits à séchage ultraviolet représentent le niveau technologique maximum atteint dans le secteur des produits de revêtement. Le processus de séchage est activé instantanément par l'énergie présente dans les rayons ultraviolets envoyés sur la surface.

Los productos con secado Ultravioleta representan el nivel tecnológico máximo alcanzado en el sector de los productos de barnizado. El proceso de secado es activado al instante por la energía presente en los rayos ultravioletas enviados en la superficie.

DATI TECNICI	COD.	P							MODEL				
ULED 2.1200	13062240	UV LED	230V 50-60Hz 2P+T	5,3 A	—	—	—	•	—	UVA LED 	↔ 350 mm UV - LED 650 x 850 mm	600x 1430x 1600H	68,0

ULED 2.2400

UV CURING



UV-STRALUNGSTROCKNER



SÈCHEURS RADIANTS À SPECTRE ULTRAVIOLET



LÁMPARA LCCL-200 PARA SECADO CON LUZ ULTRAVIOLETA



UV-A {

- Controllo digitale
- Digital control
- Steuerung digital
- Contrôle digital
- Control digital

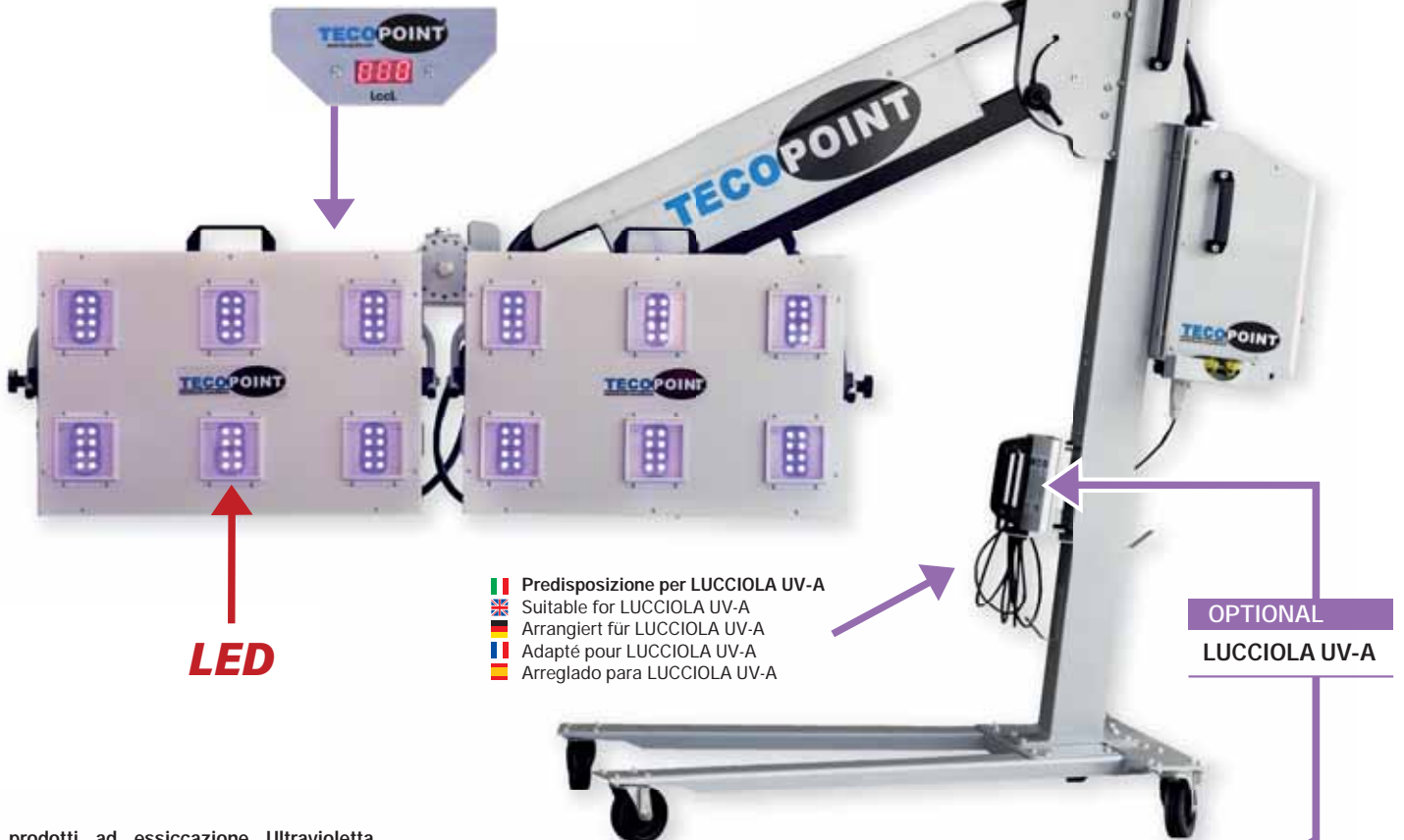

LED

Predisposizione per LUCCIOLA UV-A
 Suitable for LUCCIOLA UV-A
 Arrangiert für LUCCIOLA UV-A
 Adapté pour LUCCIOLA UV-A
 Arreglado para LUCCIOLA UV-A

OPTIONAL
LUCCIOLA UV-A

I prodotti ad essiccazione Ultravioletta rappresentano il massimo livello tecnologico raggiunto nel settore dei prodotti vernicianti. Il processo di essiccazione è attivato istantaneamente dall'energia presente nei raggi ultravioletti inviati sulla superficie.

Ultraviolet-cured coatings represent the maximum technological level in the field of paints and varnishes. The drying process is instantaneously activated by the energy of the ultraviolet rays sent on the surface.

Die UV-Trocknungsgeräte stellen das technologische Spitzenniveau der Lackierproduktebranche dar. Der Trocknungsprozess wird unmittelbar durch die in den UV-Strahlen vorhandene Energie, die auf die Oberfläche übertragen wird, aktiviert.

Les produits à séchage ultraviolet représentent le niveau technologique maximum atteint dans le secteur des produits de revêtement. Le processus de séchage est activé instantanément par l'énergie présente dans les rayons ultraviolets envoyés sur la surface.

Los productos con secado Ultravioleta representan el nivel tecnológico máximo alcanzado en el sector de los productos de barnizado. El proceso de secado es activado al instante por la energía presente en los rayos ultravioletas enviados en la superficie.



DATI TECNICI	COD.	P							MODEL				
ULED 2.2400	13062250	UV LED	230V 50-60Hz 2P+T	6 A	-	-	-	•	-	UVA LED 	↔ 350 mm UV - LED 650 x 1600mm	1000x 1100x 1600H	81,2

ULED 5.2400

- OVERHEAD SLIDING SYSTEM
- SYSTEM MIT ÜBERKOPFVERSCHIEBUNG
- SYSTÈME À GLISSEMENT AÉRIEN
- SISTEMA CON DESPLAZAMIENTO AÉREO

VISTA DI UN SISTEMA A SCORRIMENTO AEREO STANDARD.

Overhead sliding standard system.

Ansicht eines Standardsystems mit Überkopfverschiebung.

Vue d'un système à glissement aérien standard.

Vista de un sistema con desplazamiento aéreo estándar.



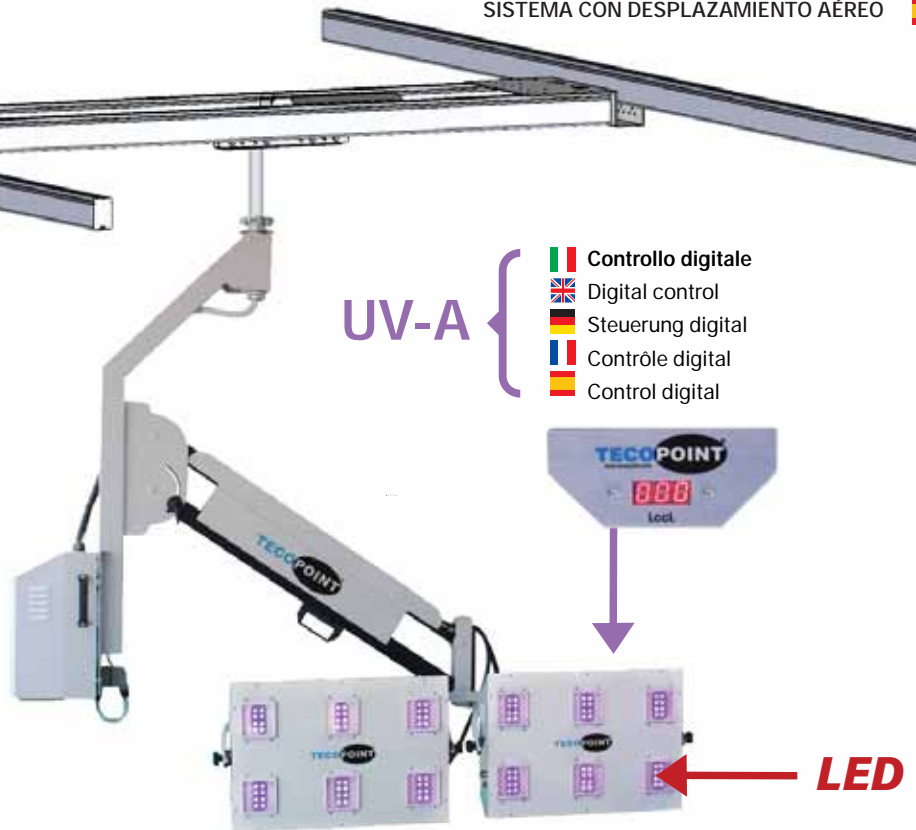

UV-A { **Controllo digitale**
 Digital control
 Steuerung digital
 Contrôle digital
 Control digital



DATI TECNICI	COD.	P							MODEL			
ULED 5.2400	13065560	UV LED	230V 50-60Hz 2P+T	6 A	-	-	-	•	-		-	-



OPTIONAL

Art. 13090265

-  Avvolgicavo
-  Cable reel
-  Kabeltrommel
-  Enrouleur de câble
-  Carrete de cable







Art. 13051510

-  Piedistallo piantana
-  Stand
-  Säule
-  Pilier
-  Pedestal poste







Art. 13094500

-  Occhiale Lente Gialla Per Uv
-  Yellow Lenses Glasses For Uv
-  Gelbe Linsenbrille Für Uv
-  Verres Jaunes Pour Uv
-  Lentes De Lentes Amarillas Para







Art. 11536087

-  Carrello
-  Shopping cart
-  Einkaufswagen
-  Panier
-  Carrito de compras







Art. 13090264

-  Supporto a parete magnetico
-  Magnetic wall support
-  Magnetische Wandhalterung
-  Support mural magnétique
-  Soporte de pared magnético



Art.13090261

-  Supporto magnetico per pistola per verniciatura
-  Magnetic support for sprayguns for painting
-  Support magnetic pour pistolet de peinture
-  Magnetische unterstützung für spritzpistole
-  Soporte magnético para pistola pulverizadora



LB 030.800

UV-IR CURING



UV-IR STRALUNGSTROCKNER



SÉCHEURS RADIANTS À SPECTRE ULTRAVIOLET ET INFRAROUGE



LÁMPARA PARA SECADO CON LUZ ULTRAVIOLETA E INFRARROJOS



I I prodotti ad essiccazione Ultravioletta rappresentano il massimo livello tecnologico raggiunto nel settore dei prodotti vernicianti. Il processo di essiccazione è attivato istantaneamente dall'energia presente nei raggi ultravioletti inviati sulla superficie.

U Ultraviolet-cured coatings represent the maximum technological level in the field of paints and varnishes. The drying process is instantaneously activated by the energy of the ultraviolet rays sent on the surface.

D Die UV-Trocknungsgeräte stellen das technologische Spitzen-niveau der Lackierproduktebranche dar. Der Trocknungsprozess wird unmittelbar durch die in den UV-Strahlen vorhandene Energie, die auf die Oberfläche übertragen wird, aktiviert.

L Les produits à séchage ultraviolet représentent le niveau technologique maximum atteint dans le secteur des produits de revêtement. Le processus de séchage est activé instantanément par l'énergie présente dans les rayons ultraviolets envoyés sur la surface.

L Los productos con secado Ultravioleta representan el nivel tecnológico máximo alcanzado en el sector de los productos de barnizado. El proceso de secado es activado al instante por la energía presente en los rayos ultravioletas enviados en la superficie.

LaBella Led

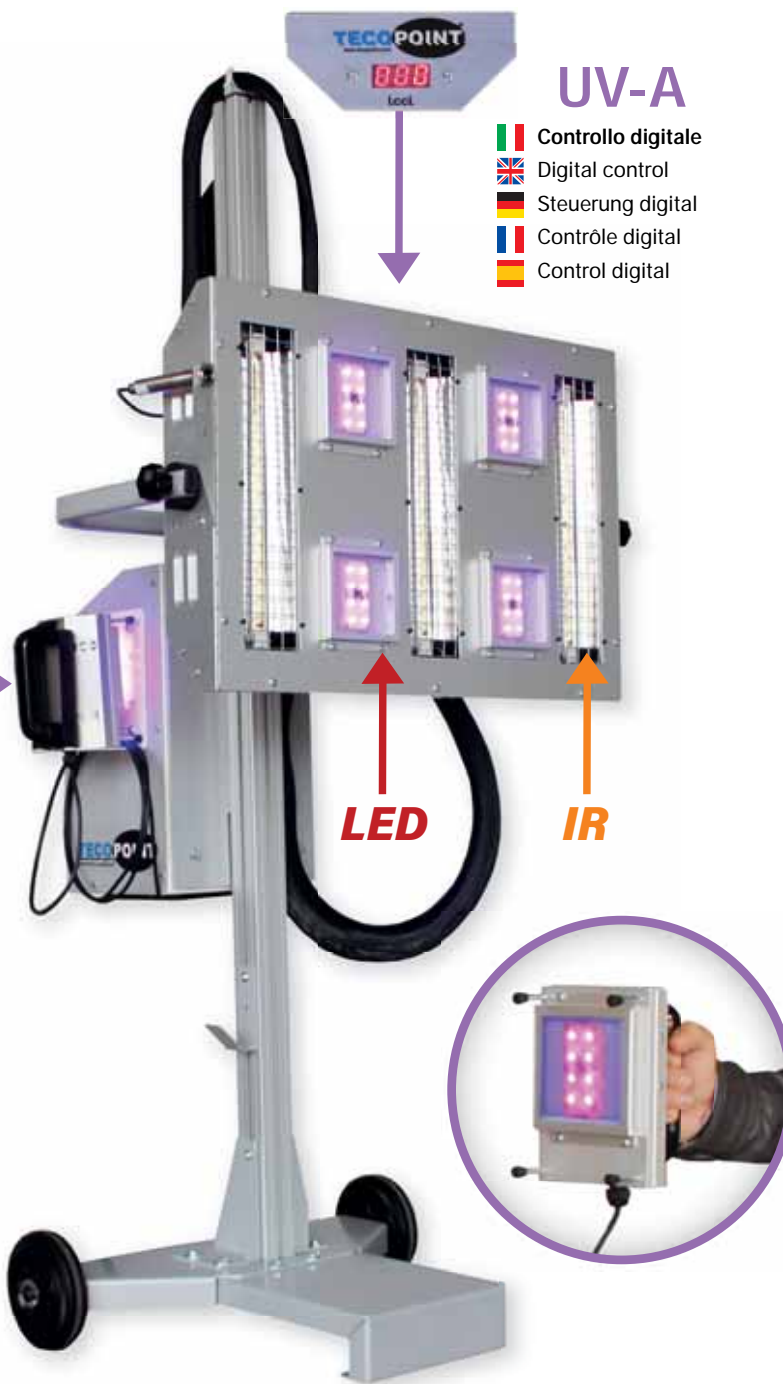

UV-A

- Controllo digitale**
- Digital control**
- Steuerung digital**
- Contrôle digital**
- Control digital**

OPTIONAL

LUCCIOLA UV-A

- Predisposizione per LUCCIOLA UV-A**
- Suitable for LUCCIOLA UV-A**
- Arrangiert für LUCCIOLA UV-A**
- Adapté pour LUCCIOLA UV-A**
- Arreglado para LUCCIOLA UV-A**



DATI TECNICI	COD.	P							MODEL		
LB 030.800	13062870	UV LED IR 3000W	230V 50-60Hz 2P+T	16 A	-	-	-	-	UVA LED IR	650 x 650 mm UV - LED 1000 x 1000 mm	68

LB 230.800

LaBella Led

UV-IR CURING



UV-IR STRALUNGSTROCKNER



SÉCHEURS RADIANTS À SPECTRE ULTRAVIOLET ET INFRAROUGE



LÁMPARA PARA SECADO CON LUZ ULTRAVIOLETA E INFRARROJOS



UV-A

- Controllo digitale
- Digital control
- Steuerung digital
- Contrôle digital
- Control digital



IR

- Controllo digitale
- Digital control
- Steuerung digital
- Contrôle digital
- Control digital

Predisposizione per LUCCIOLA UV-A

- Suitable for LUCCIOLA UV-A
- Arrangiert für LUCCIOLA UV-A
- Adapté pour LUCCIOLA UV-A
- Arreglado para LUCCIOLA UV-A

OPTIONAL

LUCCIOLA UV-A



DATI TECNICI	COD.	P							MODEL		
LB 230.800	13062880	UV LED IR 3000W	230V 50-60Hz 2P+T	16 A	-	-	-	-	UVA LED IR	650 x 650 mm UV - LED IR 1000 x 1000 mm	68,2

LB 260.1600

LaBella Led

UV-IR CURING



UV-IR STRALUNGSTROCKNER



SÉCHEURS RADIANTS À SPECTRE ULTRAVIOLET ET INFRAROUGE



LÁMPARA PARA SECADO CON LUZ ULTRAVIOLETA E INFRARROJOS



IR

Controllo digitale

Digital control

Steuerung digital

Contrôle digital

Control digital

Controllo digitale

Digital control

Steuerung digital

Contrôle digital

Control digital

UV-A



LED

IR

OPTIONAL

LUCCIOLA UV-A



Predisposizione per LUCCIOLA UV-A

Suitable for LUCCIOLA UV-A

Arrangiert für LUCCIOLA UV-A

Adapté pour LUCCIOLA UV-A

Arreglado para LUCCIOLA UV-A



DATI TECNICI	COD.	P							MODEL		
LB 260.1600	13062888	UV LED IR 6000W	400V 50-60Hz 16 A	—	—	—	•	—	UV LED IR	UV - LED IR 1000 x 2000 mm	—

LB 560.1600 VDP

LB 560.1600 ST



UV-IR CURING

UV-IR STRALUNGSTROCKNER

SÉCHEURS RADIANTS À SPECTRE ULTRAVIOLET ET INFRAROUGE

LÁMPARA PARA SECADO CON LUZ ULTRAVIOLETA E INFRARROJOS

LaBella Led

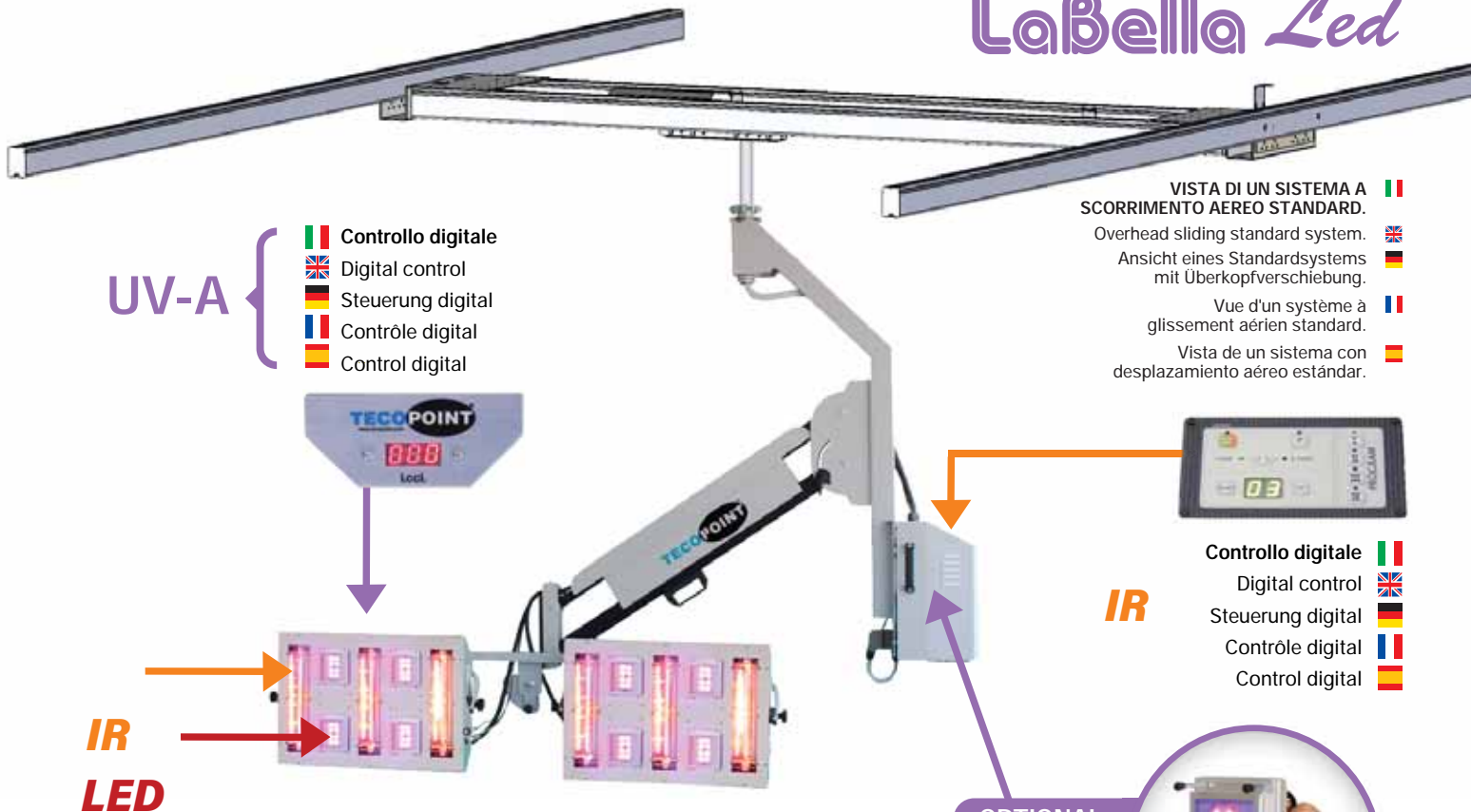

UV-A {

- Controllo digitale
- Digital control
- Steuerung digital
- Contrôle digital
- Control digital

VISTA DI UN SISTEMA A SCORRIMENTO AEREO STANDARD.
 Overhead sliding standard system.
 Ansicht eines Standardsystems mit Überkopferschiebung.
 Vue d'un système à glissement aérien standard.
 Vista de un sistema con desplazamiento aéreo estándar.

IR LED

IR

Controllo digitale
 Digital control
 Steuerung digital
 Contrôle digital
 Control digital

OPTIONAL

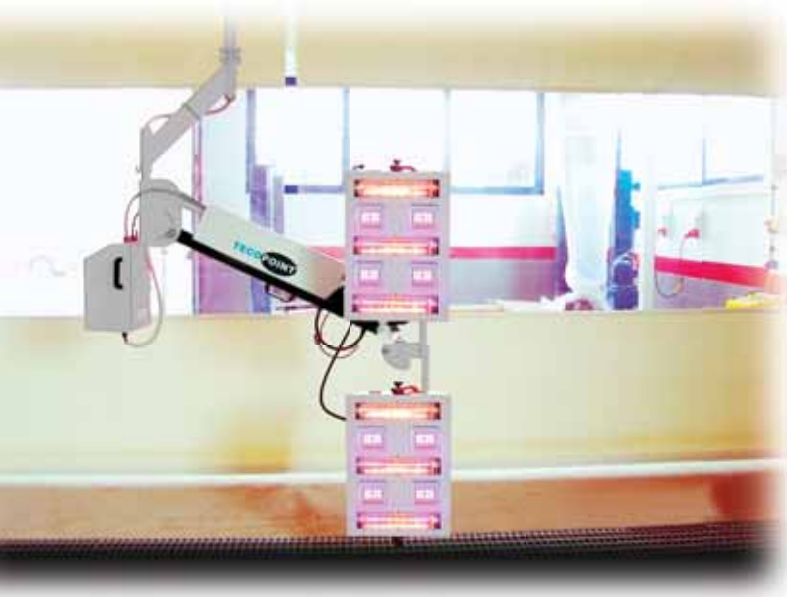

DATI TECNICI	COD.	P							MODEL		
LB 560.1600 VDP	13062935	UV LED	230V	50-60Hz	16 A	—	—	—	•	UV LED	UV - LED
LB 560.1600 ST	13062942	IR 6000W	3P+N+T	—	—	—	—	•		IR 1000 x 2000 mm	—

TETRA IR / UVA - LED

UV-IR CURING



UV-IR STRAHLUNGSTROCKNER



SÉCHEURS RADIANTS À SPECTRE ULTRAVIOLET ET INFRAROUGE



LÁMPARA PARA SECADO CON LUZ ULTRAVIOLETA E INFRARROJOS



INDUSTRIA
4.0



TETRA SMART INTEGRATION IR - UV



INTEGRAZIONE DI UVA - LED SU SISTEMI MOTORIZZATI TECOPOINT

DATI TECNICI	COD.	P							MODEL			
6120 STM TETRA mm - U	•	12 kW	400V 50-60Hz 3P+N+T	•	-	-	-	•	IR UV LED 		-	-

TECOPPOINT[®]



LccL-SLIM-800-BAT

The logo features the word "TECOPPOINT" in a bold, sans-serif font. "TECO" is in blue, and "POINT" is in white. The letters are set against a black oval background that has a glowing white border. The entire logo is centered on the page.

TECOPPOINT

www.tecopoint.com

by

ASCO 3 srl

Via Giuseppe Garibaldi 13
35020 Albignasego (PD) - Italy

info@tecopoint.com

Tel: +39 049 8629136

